

# manh truc®

## Genuine Value Retail Sales Guide



December 1, 2019

**MDS** Midwest  
WINDOW FASHIONS Designer  
Supply

[www.midwestdesignersupply.com](http://www.midwestdesignersupply.com)

**888-523-2611**  
**262-524-1007 (fax)**

Roman Shades  
Panel Track System  
Panel Drape  
Stationary Grommet Panels



Prices subject to change without notice

## CHILD SAFETY

It's your first priority, but child and pet safety is often the last thing you think about when choosing window coverings. Did you know that the most common window products in homes are not child safe? Those horizontal blinds that were there when you moved in are a potential strangulation hazard for your little ones. As our infographic shows, accidents still happen with those long cords.

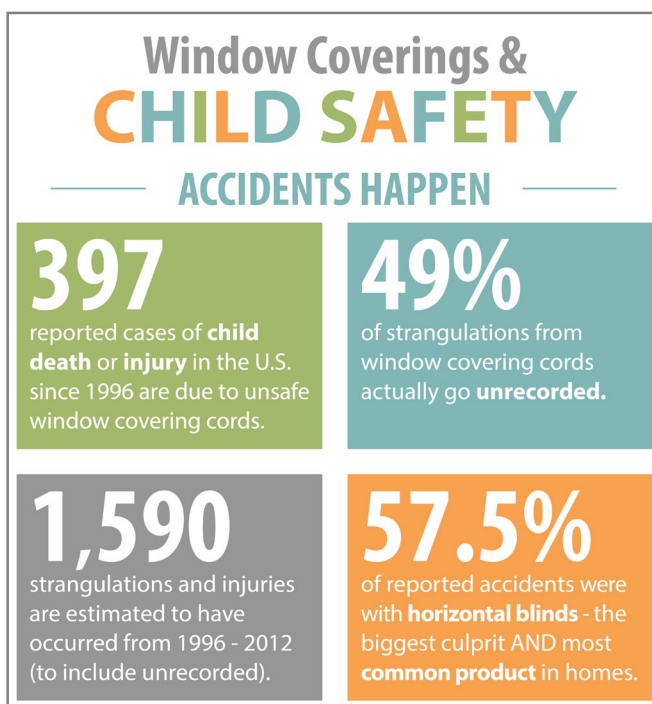

### BEST FOR KIDS™ CERTIFICATION PROGRAM

The Best for Kids™ certification label makes it easy for parents and caregivers to identify products that are best suited for their home.

To become certified, Lafayette Interior Fashions must meet the specified program criteria and submit their window covering products to a designated third party testing laboratory. To pass the tests, the products may not have:

- any operating cords
- inner cords that are accessible
- cords that create a hazardous loop or potential wrap-around hazard



### ADDITIONAL SAFETY MEASURES

The window covering industry uses warning tags, labels, and other methods to communicate potential hazards. The warning shown here communicates the important message that cords are a potential strangulation hazard and suggests choosing cordless or inaccessible-cord alternatives. Together with the Window Covering Safety Council, we encourage you to install only cordless window coverings in rooms where children play and sleep.



For kids' sake, we offer a wide array of lifting system options, from cordless and motorized operating systems to retractable lift cords, cord tensioners, and wand controls for enhanced child safety.

All Lafayette products that utilize a clutch system are sent with a Cord Tension Lock. The Cord Tension Lock must be secured to the wall to provide the necessary tension for the shade to operate.

All **motorized** window treatment products offer child safe operation since the motor unit provides the mechanism for raising and lowering the shade.

For additional window treatment child safety information, please visit the Window Covering Safety Council ([www.windowcoverings.org](http://www.windowcoverings.org)).

# TABLE OF CONTENTS

SPECIFICATION CHARTS	Page	PRICING	Page	PRODUCT INFORMATION	Page
<b>Fabric Information</b>	<b>3</b>	<b>Flat &amp; Hobbled Shades</b>		<b>Flat &amp; Hobbled Shades</b>	
<b>Roman Shades - Size Standards</b>		Chart FA	17	Cordlock System	34
Cordlock System	4	Chart HA	17	Clutch System	35
Clutch System	4	Chart F1	18	CareRING Cordless	36
CareRING Cordless	4	Chart H1	18	Duo-Shade	37
2/3-on-1 Headrail	9	Chart F2	19	Specialties	38-39
Top-Down Bottom-Up	9	Chart H2	19	System II Motorization	40-41
Duo-Shade	9	Chart F3	20	Sonesse 30 WireFree Motorization	40-41
Arch/Angle Top Shade	9	Chart H3	20	R28 WireFree Motorization	40-41
Arch	9	Chart F4	21	Ultra 30 WireFree Motorization	40-41
Angle	9	Chart H4	21	Auto-Wand Motorization	42,44
System II & WireFree Motorization	40	Chart F5	22	EZ Charge Motorization	43-44
Auto-Wand & EZ Charge Motorization	42-43	Chart H5	22		
		Chart F6	23	<b>Panel Track</b>	<b>45</b>
		Chart H6	23		
<b>Panel Track</b>		Duo-Shade Lining Surcharges	24	<b>Panel Drape</b>	<b>46</b>
Size Standards	11	Additional Option Surcharges	24		
Track Configurations	15	Arch Surcharges	24	<b>Stationary Grommet Panel</b>	<b>47</b>
Panel Configurations/Widths	16	Motorization	25-26		
				<b>Design Options</b>	
<b>Panel Drape</b>		<b>Panel Track</b>		Valances & Cornices	48
Size Standards	11	Chart PT1	27	Design Options	49-50
		Chart PT2	27		
<b>Stationary Grommet Panel</b>		Chart PT3	28	<b>MEASURING &amp; INSTALLATION</b>	<b>51-52</b>
Size Standards	11	Chart PT4	28		
		Lining & Options Surcharges	29	<b>COLOR AVAILABILITY</b>	<b>53</b>
<b>Design Options</b>					
Cornices	10	<b>Panel Drape</b>			
Lift Systems Availability	12	Charts PD1 & PD2	30		
All Other Options	12	Charts PD3 & PD4	31		
		Charts PD5	32		
<b>Finished Dimensions &amp; Mounting Requirements</b>		Options Surcharges	32		
Flat Roman	13				
Hobbled Roman	13	<b>Stationary Grommet Panel</b>			
Duo-Shade	13	Charts 1 & 2	33		
Panel Track	14	Charts 3 & 4	33		
Panel Drape	14	Charts 5	33		
Stationary Grommet Panel	14				
<b>Stacking Heights</b>	<b>14</b>				

• Please examine all merchandise and packages for accuracy and make sure all parts, brackets, etc. are included before sending them to be installed. While we constantly strive to make sure each order is exact and complete, we do occasionally make mistakes, and we cannot be responsible for trip charges or reinstallation charges. **Repairs or remakes must be requested within 30 days of invoice date.**

• Manh Truc materials are made from natural materials and will have visible imperfections. Some natural patterns offer slight differences in grain and texture, especially in materials containing knots or slight surface cracks. The finest native materials in shades contain some variations in color and hue. In addition, natural materials can have a slight bow or camber so that horizontal lines or bottom hems might not be perfectly straight. Fold alignment can vary slightly, even on shades that are the same height. Shades made of natural materials tend to stretch slightly over time.

## Manh Truc Fabric Information

Pattern Name	Maximum Shade Width ◊	Flat Roman Chart	Hobbled Roman Chart	Edge Banding Roman Shades	Panel Track Chart	Panel Drape Chart	Stationary Grommet Panel	Bottom Banding Panel Drape/ Grommet Panel
Akela	118"	F4	H4	Y	N/A	PD4	G4	N/A
Aris	118"	F2	H2	Y	PT2	PD2	G2	Y
Bacopa+	96"	F1	N/A	N/A	N/A	N/A	N/A	N/A
Batang	96"	FA	HA	Y	N/A	PD1	G1	Y
Bayani	96"	F1	H1	Y	PT1	PD1	G1	Y
Beijing	118"	F2	H2	Y	N/A	PD2	G2	Y
Caracas+	72"	F2	N/A	N/A	N/A	N/A	N/A	N/A
Chakra	118"	F4	H4	Y	N/A	N/A	N/A	N/A
Chinda	118"	F2	H2	Y	N/A	PD2	G2	N/A
Dieu	96"	F2	H2	Y	N/A	PD2	G2	Y
Georgie+	72"	F6	H6	Y	N/A	PD5	G5	Y
Hanoi+	94"	F4	N/A	Y	PT4	PD4	G4	N/A
Jambu+	118"	F1	H1	Y	PT1	PD1	G1	N/A
Jilin	118"	F1	H1	Y	PT1	PD1	G1	Y
Kaila+	72"	F5	H5	Y	N/A	PD5	G5	N/A
Kaliko	96"	F3	H3	Y	N/A	PD3	G3	N/A
Karina**+	96"	F4	H4	Y	N/A	PD4	G4	Y
Kato+	96"	F3	H3	Y	N/A	PD3	G3	N/A
Keani	96"	F5	H5	Required*	N/A	PD5	N/A	Y
Kwan	96"	F3	H3	Y	N/A	PD3	G3	N/A
Lani+	96"	F6	H6	Y	N/A	PD5	G5	N/A
Lea	118"	F4	H4	Y	N/A	PD4	G4	N/A
Malana+	96"	F6	H6	Required*	N/A	PD5	G5	N/A
Mayli	96"	F3	H3	Y	N/A	N/A	N/A	N/A
Meeka**+	96"	F6	H6	Y	N/A	PD5	N/A	Y
Miya	118"	F3	H3	Y	PT3	PD3	G3	N/A
Naoki	118"	F1	H1	N/A	N/A	N/A	N/A	N/A
Nara+	96"	F4	H4	Y	PT4	PD4	G4	Y
Okalani	118"	F5	H5	Y	N/A	PD5	G5	Y
Sapporo	96"	F1	H1	N/A	N/A	N/A	N/A	N/A
Sasarido	118"	F3	H3	Y	N/A	PD3	G3	Y
Sibu+	96"	F2	N/A	Y	N/A	N/A	N/A	N/A
Srilanka	96"	F3	H3	Y	N/A	N/A	N/A	N/A
Ulani	96"	F2	H2	Y	PT2	PD2	G2	Y
Waja+	118"	F3	H3	Y	PT3	PD3	G3	N/A
Zaru+	96"	F3	H3	Y	PT3	PD3	G3	Y
Zuki	96"	F4	H4	Y	N/A	N/A	N/A	N/A

\* Add a surcharge

\*\* Can not be spearlined

+ Patterns do NOT have horizontal alignment from shade to shade and are not recommended for multiple shades on one headrail.

◊ Lift system dependent

# Size Standards - Roman Shades - Standard Rectangular

Pattern	Cordlock System				Clutch System				CareRing Cordless			
	Flat Roman		Hobbled Roman		Flat Roman		Hobbled Roman					
	Max Width	Max Height	Max Width	Max Height	Max Width	Max Height	Max Width	Max Height	Flat Unlined Sz Chart	Flat LF Lining Sz Chart	Flat OP Lining Sz Chart	Hobbled Unlined Sz Chart
Akela	118"	120"	118"	96"	118"	120"/96"	118"	120"/96"	F1	LF1	OP1	H1
Aris	118"	120"	118"	96"	118"	120"/96"	118"	120"/96"	F2	LF2	OP2	H2
Bacopa	96"	120"	N/A	N/A	96"	120"/96"	N/A	N/A	F4	LF4	OP4	N/A
Batang	96"	120"	96"	96"	96"	120"/96"	96"	120"/96"	F2	LF2	OP2	H2
Bayani	96"	120"	96"	96"	96"	120"/96"	96"	120"/96"	F1	LF1	OP1	H1
Beijing	118"	120"	118"	96"	118"	120"/96"	118"	120"/96"	F1	LF1	OP1	H1
Caracas	72"	84"	N/A	N/A	72"	84"	N/A	N/A	N/A	N/A	N/A	N/A
Chakra	118"	120"	118"	96"	118"	120"/96"	118"	120"/96"	F1	LF1	OP1	H1
Chinda	118"	120"	118"	96"	118"	120"/96"	118"	120"/96"	F1	LF1	OP1	H1
Dieu	96"	120"	96"	96"	96"	120"/96"	96"	120"/96"	F1	LF1	OP1	H1
Georgie	72"	84"	72"	84"	72"	84"	N/A	N/A	F1	LF1	OP1	N/A
Hanoi	94"	120"	N/A	N/A	94"	120"/96"	N/A	N/A	F1	LF1	OP1	N/A
Jambu	118"	120"	118"	96"	118"	120"/96"	118"	120"/96"	F2	LF2	OP2	H2
Jilin	118"	120"	118"	96"	118"	120"/96"	118"	120"/96"	F3	LF3	OP3	H3
Kaila	72"	120"	72"	96"	72"	120"/96"	72"	120"/96"	F1	LF1	OP1	H1
Kaliko	96"	120"	96"	96"	96"	120"/96"	96"	120"/96"	F1	LF1	OP1	H1
Karina	96"	120"	96"	96"	96"	120"/96"	96"	120"/96"	F1	LF1	OP1	H1
Kato	96"	120"	96"	96"	96"	120"/96"	96"	120"/96"	F1	LF1	OP1	H1
Keani	96"	120"	96"	96"	96"	120"/96"	96"	120"/96"	N/A	N/A	N/A	N/A
Kwan	96"	120"	96"	96"	96"	120"/96"	96"	120"/96"	F1	LF1	OP1	H1
Lani	96"	120"	96"	96"	96"	120"/96"	96"	120"/96"	F1	LF1	OP1	H1
Lea	118"	120"	118"	96"	118"	120"/96"	118"	120"/96"	F1	LF1	OP1	H1
Malana	96"	120"	96"	96"	96"	120"/96"	96"	120"/96"	N/A	N/A	N/A	N/A
Mayli	96"	120"	96"	96"	96"	120"/96"	96"	120"/96"	F1	LF1	OP1	H1
Meeka	96"	120"	96"	96"	96"	120"/96"	96"	120"/96"	F2	LF2	OP2	H2
Miya	118"	120"	118"	96"	118"	120"/96"	118"	120"/96"	F1	LF1	OP1	H1
Naoki	118"	120"	118"	96"	118"	120"/96"	118"	120"/96"	F2	LF2	OP2	H2
Nara	96"	120"	96"	96"	96"	120"/96"	96"	120"/96"	F1	LF1	OP1	H1
Okalani	118"	120"	118"	96"	118"	120"/96"	118"	120"/96"	F1	LF1	OP1	H1
Sapporo	96"	120"	96"	96"	96"	120"/96"	96"	120"/96"	F3	LF3	OP3	H3
Sasarido	118"	120"	118"	96"	118"	120"/96"	118"	120"/96"	F1	LF1	OP1	H1
Sibu	96"	120"	N/A	N/A	96"	120"/96"	N/A	N/A	F1	LF1	OP1	N/A
Srilanka	96"	120"	96"	96"	96"	120"/96"	96"	120"/96"	F1	LF1	OP1	H1
Ulani	96"	120"	96"	96"	96"	120"/96"	96"	120"/96"	F1	LF1	OP1	H1
Waja	118"	120"	118"	96"	118"	120"/96"	118"	120"/96"	F1	LF1	OP1	H1
Zaru	96"	120"	96"	96"	96"	120"/96"	96"	120"/96"	F1	LF1	OP1	H1
Zuki	96"	120"	96"	96"	96"	120"/96"	96"	120"/96"	F1	LF1	OP1	H1
	Min Width	Min Height	Min Width	Min Height	Min Width	Min Height	Min Width	Min Height	Min Width	Min Height	Min Width	Min Height
<b>Minimums</b>	15"	30"	15"	30"	15"/24**	30"	15"/24**	30"	18 1/2"	26 1/2"	26 1/2"	26 1/2"

\* Quick Lift Clutch has minimum width of 15" and max. length of 120"; Traditional Clutch has minimum width of 24" and max. length of 96".

[Click for Easy Search View](#)

# Size Standards - Flat Roman w/ CareRing Cordless

F1	Shade Width Up To:												LF1												
	18 $\frac{1}{2}$ "	26 $\frac{7}{16}$ "	26 $\frac{1}{2}$ "	30"	36"	42"	48"	54"	60"	66"	72"	78"		18 $\frac{1}{2}$ "	26 $\frac{7}{16}$ "	26 $\frac{1}{2}$ "	30"	36"	42"	48"	54"	60"	66"	72"	78"
Shade Height Up To:	24"	Y	Y	Y	Y	Y	Y	Y	Y	Y	Y	Y	24"	Y	Y	Y	Y	Y	Y	Y	Y	Y	Y	Y	
	30"	Y	Y	Y	Y	Y	Y	Y	Y	Y	Y	Y	30"	Y	Y	Y	Y	Y	Y	Y	Y	Y	Y	Y	
	36"	Y	Y	Y	Y	Y	Y	Y	Y	Y	Y	Y	36"	Y	N/A	Y	Y	Y	Y	Y	Y	Y	Y	Y	
	42"	Y	Y	Y	Y	Y	Y	Y	Y	Y	Y	Y	42"	Y	N/A	Y	Y	Y	Y	Y	Y	Y	Y	Y	
	48"	Y	N/A	Y	Y	Y	Y	Y	Y	Y	Y	Y	48"	Y	N/A	Y	Y	Y	Y	Y	Y	Y	Y	Y	
	54"	Y	N/A	Y	Y	Y	Y	Y	Y	Y	Y	Y	54"	N/A	N/A	Y	Y	Y	Y	Y	Y	Y	Y	Y	
	60"			Y	Y	Y	Y	Y	Y	Y	Y	Y	60"			Y	Y	Y	Y	Y	Y	Y	Y	Y	
	66"			Y	Y	Y	Y	Y	Y	Y	Y	Y	66"			Y	Y	Y	Y	Y	Y	Y	Y	Y	
	72"			Y	Y	Y	Y	Y	Y	Y	Y	Y	72"			Y	Y	Y	Y	Y	Y	Y	Y	N/A	
	78"			Y	Y	Y	Y	Y	Y	Y	Y	Y	78"			Y	Y	Y	Y	Y	Y	Y	N/A	N/A	
84"			Y	Y	Y	Y	Y	Y	Y	Y	N/A	84"			N/A	Y	Y	Y	Y	Y	Y	N/A	N/A		

OP1	Shade Width Up To:												H1												
	18 $\frac{1}{2}$ "	26 $\frac{7}{16}$ "	26 $\frac{1}{2}$ "	30"	36"	42"	48"	54"	60"	66"	72"	78"		18 $\frac{1}{2}$ "	26 $\frac{7}{16}$ "	26 $\frac{1}{2}$ "	30"	36"	42"	48"	54"	60"	66"	72"	78"
Shade Height Up To:	24"	Y	Y	Y	Y	Y	Y	Y	Y	Y	Y	Y	24"	Y	N/A	Y	Y	Y	Y	Y	Y	Y	Y	Y	
	30"	Y	Y	Y	Y	Y	Y	Y	Y	Y	Y	Y	30"	N/A	N/A	Y	Y	Y	Y	Y	Y	Y	Y	Y	
	36"	Y	N/A	Y	Y	Y	Y	Y	Y	Y	Y	Y	36"	N/A	N/A	Y	Y	Y	Y	Y	Y	Y	N/A	N/A	
	42"	Y	N/A	Y	Y	Y	Y	Y	Y	Y	Y	Y	42"	N/A	N/A	N/A	Y	Y	Y	Y	Y	N/A	N/A	N/A	
	48"	Y	N/A	Y	Y	Y	Y	Y	Y	Y	Y	Y	48"	N/A	N/A	N/A	Y	Y	Y	Y	N/A	N/A	N/A	N/A	
	54"	N/A	N/A	Y	Y	Y	Y	Y	Y	Y	Y	Y	54"	N/A	N/A	N/A	N/A	Y	Y	N/A	N/A	N/A	N/A	N/A	
	60"			Y	Y	Y	Y	Y	Y	Y	Y	Y	60"			N/A	N/A	Y	Y	N/A	N/A	N/A	N/A	N/A	
	66"			Y	Y	Y	Y	Y	Y	Y	Y	N/A	66"			N/A	N/A	Y	N/A	N/A	N/A	N/A	N/A	N/A	
	72"			Y	Y	Y	Y	Y	Y	Y	N/A	N/A	72"			N/A	N/A	Y	N/A	N/A	N/A	N/A	N/A	N/A	
	78"			N/A	Y	Y	Y	Y	Y	Y	N/A	N/A	78"			N/A	N/A	N/A	N/A	N/A	N/A	N/A	N/A	N/A	
84"			N/A	Y	Y	Y	Y	Y	Y	N/A	N/A	84"			N/A	N/A	N/A	N/A	N/A	N/A	N/A	N/A	N/A		

# Size Standards - Flat Roman w/ CareRing Cordless

	F2	Shade Width Up To:												LF2	Shade Width Up To:											
		18½"	26⅞"	26½"	30"	36"	42"	48"	54"	60"	66"	72"	78"		18½"	26⅞"	26½"	30"	36"	42"	48"	54"	60"	66"	72"	78"
Shade Height Up To:	24"	Y	Y	Y	Y	Y	Y	Y	Y	Y	Y	Y	Y	24"	Y	Y	Y	Y	Y	Y	Y	Y	Y	Y	Y	
	30"	Y	Y	Y	Y	Y	Y	Y	Y	Y	Y	Y	Y	30"	Y	Y	Y	Y	Y	Y	Y	Y	Y	Y	Y	
	36"	Y	Y	Y	Y	Y	Y	Y	Y	Y	Y	Y	Y	36"	Y	N/A	Y	Y	Y	Y	Y	Y	Y	Y	Y	
	42"	Y	N/A	Y	Y	Y	Y	Y	Y	Y	Y	Y	Y	42"	Y	N/A	Y	Y	Y	Y	Y	Y	Y	Y	Y	
	48"	Y	N/A	Y	Y	Y	Y	Y	Y	Y	Y	Y	Y	48"	Y	N/A	Y	Y	Y	Y	Y	Y	Y	Y	Y	
	54"	Y	N/A	Y	Y	Y	Y	Y	Y	Y	Y	Y	Y	54"	N/A	N/A	Y	Y	Y	Y	Y	Y	Y	Y	Y	
	60"			Y	Y	Y	Y	Y	Y	Y	Y	Y	Y	60"			Y	Y	Y	Y	Y	Y	Y	Y	Y	
	66"			Y	Y	Y	Y	Y	Y	Y	Y	Y	Y	66"			Y	Y	Y	Y	Y	Y	Y	Y	N/A	
	72"			Y	Y	Y	Y	Y	Y	Y	Y	Y	Y	72"			Y	Y	Y	Y	Y	Y	Y	N/A	N/A	
	78"			Y	Y	Y	Y	Y	Y	Y	Y	N/A	N/A	78"			N/A	Y	Y	Y	Y	Y	N/A	N/A	N/A	
84"			Y	Y	Y	Y	Y	Y	Y	Y	N/A	N/A	84"			N/A	Y	Y	Y	Y	Y	N/A	N/A	N/A		

	OP2	Shade Width Up To:												H2	Shade Width Up To:									
		18½"	26⅞"	26½"	30"	36"	42"	48"	54"	60"	66"	72"	78"		26½"	30"	36"	42"	48"	54"	60"	66"	72"	78"
Shade Height Up To:	24"	Y	Y	Y	Y	Y	Y	Y	Y	Y	Y	Y	24"	Y	Y	Y	Y	Y	Y	Y	Y	Y	Y	
	30"	Y	N/A	Y	Y	Y	Y	Y	Y	Y	Y	Y	30"	Y	Y	Y	Y	Y	Y	Y	Y	Y	N/A	
	36"	Y	N/A	Y	Y	Y	Y	Y	Y	Y	Y	Y	36"	N/A	Y	Y	Y	Y	Y	Y	N/A	N/A	N/A	
	42"	Y	N/A	Y	Y	Y	Y	Y	Y	Y	Y	Y	42"	N/A	Y	Y	Y	Y	Y	N/A	N/A	N/A	N/A	
	48"	N/A	N/A	Y	Y	Y	Y	Y	Y	Y	Y	Y	48"	N/A	N/A	Y	Y	Y	N/A	N/A	N/A	N/A	N/A	
	54"	N/A	N/A	Y	Y	Y	Y	Y	Y	Y	Y	Y	54"	N/A	N/A	Y	Y	N/A	N/A	N/A	N/A	N/A	N/A	
	60"			Y	Y	Y	Y	Y	Y	Y	Y	N/A	60"	N/A	N/A	Y	N/A	N/A	N/A	N/A	N/A	N/A	N/A	
	66"			Y	Y	Y	Y	Y	Y	Y	N/A	N/A	66"	N/A	N/A	N/A	N/A	N/A	N/A	N/A	N/A	N/A	N/A	
	72"			N/A	Y	Y	Y	Y	Y	N/A	N/A	N/A	72"	N/A	N/A	N/A	N/A	N/A	N/A	N/A	N/A	N/A	N/A	
	78"			N/A	Y	Y	Y	Y	Y	N/A	N/A	N/A	78"	N/A	N/A	N/A	N/A	N/A	N/A	N/A	N/A	N/A	N/A	
84"			N/A	Y	Y	Y	Y	Y	N/A	N/A	N/A	84"	N/A	N/A	N/A	N/A	N/A	N/A	N/A	N/A	N/A	N/A		

# Size Standards - Flat Roman w/ CareRing Cordless

F3	Shade Width Up To:												LF3	Shade Width Up To:											
	18½"	26⅞"	26½"	30"	36"	42"	48"	54"	60"	66"	72"	78"		18½"	26⅞"	26½"	30"	36"	42"	48"	54"	60"	66"	72"	78"
Shade Height Up To:	24"	Y	Y	Y	Y	Y	Y	Y	Y	Y	Y	Y	24"	Y	Y	Y	Y	Y	Y	Y	Y	Y	Y	Y	
	30"	Y	Y	Y	Y	Y	Y	Y	Y	Y	Y	Y	30"	Y	N/A	Y	Y	Y	Y	Y	Y	Y	Y	Y	
	36"	Y	N/A	Y	Y	Y	Y	Y	Y	Y	Y	Y	36"	Y	N/A	Y	Y	Y	Y	Y	Y	Y	Y	Y	
	42"	Y	N/A	Y	Y	Y	Y	Y	Y	Y	Y	Y	42"	Y	N/A	Y	Y	Y	Y	Y	Y	Y	Y	Y	
	48"	Y	N/A	Y	Y	Y	Y	Y	Y	Y	Y	Y	48"	N/A	N/A	Y	Y	Y	Y	Y	Y	Y	Y	Y	
	54"	N/A	N/A	Y	Y	Y	Y	Y	Y	Y	Y	Y	54"	N/A	N/A	Y	Y	Y	Y	Y	Y	Y	Y	Y	
	60"			Y	Y	Y	Y	Y	Y	Y	Y	Y	60"			Y	Y	Y	Y	Y	Y	Y	Y	N/A	
	66"			Y	Y	Y	Y	Y	Y	Y	Y	Y	66"			Y	Y	Y	Y	Y	Y	Y	N/A	N/A	
	72"			Y	Y	Y	Y	Y	Y	Y	Y	N/A	72"			N/A	Y	Y	Y	Y	Y	N/A	N/A	N/A	
	78"			Y	Y	Y	Y	Y	Y	Y	N/A	N/A	78"			N/A	Y	Y	Y	Y	N/A	N/A	N/A	N/A	
84"			N/A	Y	Y	Y	Y	Y	N/A	N/A	N/A	84"			N/A	Y	Y	Y	Y	N/A	N/A	N/A	N/A		

OP3	Shade Width Up To:												H3	Shade Width Up To:									
	18½"	26⅞"	26½"	30"	36"	42"	48"	54"	60"	66"	72"	78"		26½"	30"	36"	42"	48"	54"	60"	66"	72"	78"
Shade Height Up To:	24"	Y	Y	Y	Y	Y	Y	Y	Y	Y	Y	Y	24"	Y	Y	Y	Y	Y	Y	Y	Y	Y	Y
	30"	Y	N/A	Y	Y	Y	Y	Y	Y	Y	Y	Y	30"	Y	Y	Y	Y	Y	Y	Y	N/A	N/A	
	36"	Y	N/A	Y	Y	Y	Y	Y	Y	Y	Y	Y	36"	N/A	Y	Y	Y	Y	N/A	N/A	N/A	N/A	
	42"	Y	N/A	Y	Y	Y	Y	Y	Y	Y	Y	Y	42"	N/A	Y	Y	Y	N/A	N/A	N/A	N/A	N/A	
	48"	N/A	N/A	Y	Y	Y	Y	Y	Y	Y	Y	Y	48"	N/A	N/A	Y	Y	N/A	N/A	N/A	N/A	N/A	
	54"	N/A	N/A	Y	Y	Y	Y	Y	Y	Y	Y	N/A	54"	N/A	N/A	Y	N/A	N/A	N/A	N/A	N/A	N/A	
	60"			Y	Y	Y	Y	Y	Y	Y	N/A	N/A	60"	N/A	N/A	Y	N/A	N/A	N/A	N/A	N/A	N/A	
	66"			N/A	Y	Y	Y	Y	Y	N/A	N/A	N/A	66"	N/A	N/A	N/A	N/A	N/A	N/A	N/A	N/A	N/A	
	72"			N/A	Y	Y	Y	Y	N/A	N/A	N/A	N/A	72"	N/A	N/A	N/A	N/A	N/A	N/A	N/A	N/A	N/A	
	78"			N/A	Y	Y	Y	Y	N/A	N/A	N/A	N/A	78"	N/A	N/A	N/A	N/A	N/A	N/A	N/A	N/A	N/A	
84"			N/A	Y	Y	Y	Y	N/A	N/A	N/A	N/A	84"	N/A	N/A	N/A	N/A	N/A	N/A	N/A	N/A	N/A		



# Manh Truc Hobbled Roman with CareRING Cordless

F4	Shade Width Up To:												LF4	Shade Width Up To:											
	18½"	26⅞"	26½"	30"	36"	42"	48"	54"	60"	66"	72"	78"		18½"	26⅞"	26½"	30"	36"	42"	48"	54"	60"	66"	72"	78"
Shade Height Up To:	24"	Y	Y	Y	Y	Y	Y	Y	Y	Y	Y	Y	Y	24"	Y	Y	Y	Y	Y	Y	Y	Y	Y	Y	Y
	30"	Y	Y	Y	Y	Y	Y	Y	Y	Y	Y	Y	Y	30"	Y	N/A	Y	Y	Y	Y	Y	Y	Y	Y	Y
	36"	Y	N/A	Y	Y	Y	Y	Y	Y	Y	Y	Y	Y	36"	Y	N/A	Y	Y	Y	Y	Y	Y	Y	Y	Y
	42"	Y	N/A	Y	Y	Y	Y	Y	Y	Y	Y	Y	Y	42"	N/A	N/A	Y	Y	Y	Y	Y	Y	Y	Y	Y
	48"	N/A	N/A	Y	Y	Y	Y	Y	Y	Y	Y	Y	Y	48"	N/A	N/A	Y	Y	Y	Y	Y	Y	Y	Y	Y
	54"	N/A	N/A	Y	Y	Y	Y	Y	Y	Y	Y	Y	Y	54"	N/A	N/A	Y	Y	Y	Y	Y	Y	Y	Y	N/A
	60"			Y	Y	Y	Y	Y	Y	Y	Y	Y	N/A	60"			Y	Y	Y	Y	Y	Y	Y	N/A	N/A
	66"			Y	Y	Y	Y	Y	Y	Y	N/A	N/A	N/A	66"			N/A	Y	Y	Y	Y	Y	N/A	N/A	N/A
	72"			N/A	Y	Y	Y	Y	Y	Y	N/A	N/A	N/A	72"			N/A	Y	Y	Y	Y	Y	N/A	N/A	N/A
	78"			N/A	Y	Y	Y	Y	Y	Y	N/A	N/A	N/A	78"			N/A	Y	Y	Y	Y	N/A	N/A	N/A	N/A
84"			N/A	Y	Y	Y	Y	Y	Y	N/A	N/A	N/A	84"			N/A	N/A	Y	Y	Y	N/A	N/A	N/A	N/A	

OP4	Shade Width Up To:												H4										
	18½"	26⅞"	26½"	30"	36"	42"	48"	54"	60"	66"	72"	78"		26½"	30"	36"	42"	48"	54"	60"	66"	72"	78"
Shade Height Up To:	24"	Y	Y	Y	Y	Y	Y	Y	Y	Y	Y	Y	24"	Y	Y	Y	Y	Y	Y	Y	Y	Y	Y
	30"	Y	N/A	Y	Y	Y	Y	Y	Y	Y	Y	Y	30"	N/A	Y	Y	Y	Y	Y	Y	N/A	N/A	N/A
	36"	Y	N/A	Y	Y	Y	Y	Y	Y	Y	Y	Y	36"	N/A	Y	Y	Y	Y	Y	N/A	N/A	N/A	N/A
	42"	N/A	N/A	Y	Y	Y	Y	Y	Y	Y	Y	Y	42"	N/A	N/A	Y	Y	N/A	N/A	N/A	N/A	N/A	N/A
	48"	N/A	N/A	Y	Y	Y	Y	Y	Y	Y	Y	Y	48"	N/A	N/A	Y	N/A	N/A	N/A	N/A	N/A	N/A	N/A
	54"	N/A	N/A	Y	Y	Y	Y	Y	Y	Y	N/A	N/A	54"	N/A	N/A	Y	N/A	N/A	N/A	N/A	N/A	N/A	N/A
	60"			N/A	Y	Y	Y	Y	Y	Y	N/A	N/A	60"	N/A	N/A	N/A	N/A	N/A	N/A	N/A	N/A	N/A	N/A
	66"			N/A	Y	Y	Y	Y	Y	N/A	N/A	N/A	66"	N/A	N/A	N/A	N/A	N/A	N/A	N/A	N/A	N/A	N/A
	72"			N/A	Y	Y	Y	Y	Y	N/A	N/A	N/A	72"	N/A	N/A	N/A	N/A	N/A	N/A	N/A	N/A	N/A	N/A
	78"			N/A	Y	Y	Y	Y	N/A	N/A	N/A	N/A	78"	N/A	N/A	N/A	N/A	N/A	N/A	N/A	N/A	N/A	N/A
84"			N/A	N/A	Y	Y	N/A	N/A	N/A	N/A	N/A	84"	N/A	N/A	N/A	N/A	N/A	N/A	N/A	N/A	N/A	N/A	

# Size Standards - Roman Shades - Options

Pattern	2-on-1 / 3-on-1 Headrail			Top Down/Bottom Up		Flat Roman Duo Shade		Angle/Arch Top		Arch		Angle		Wood Bottom Hem
	Max Width	Flat	Hobbed	Max Width	Max Height	Max Width	Max Height	Max Width	Max Height	Max Width	Max Height	Max Width	Max Height	Max Width
		Max Height	Max Height											
Akela	144"	120"	96"	96"	108"	84"	96"	N/A	N/A	N/A	N/A	N/A	N/A	72"
Aris	144"	120"	96"	96"	108"	84"	96"	60"	108"	60"	30"	60"	48"	72"
Bacopa	144"	120"	N/A	96"	108"	84"	96"	N/A	N/A	N/A	N/A	N/A	N/A	72"
Batang	144"	120"	96"	96"	108"	84"	96"	60"	108"	60"	30"	60"	48"	72"
Bayani	144"	120"	96"	96"	108"	84"	96"	N/A	N/A	N/A	N/A	N/A	N/A	72"
Beijing	144"	120"	96"	95"	108"	84"	96"	N/A	N/A	N/A	N/A	N/A	N/A	72"
Caracas	144"	84"	N/A	72"	84"	72"	84"	N/A	N/A	N/A	N/A	N/A	N/A	N/A
Chakra	144"	120"	96"	96"	108"	84"	96"	N/A	N/A	N/A	N/A	N/A	N/A	72"
Chinda	144"	120"	96"	96"	108"	84"	96"	N/A	N/A	N/A	N/A	N/A	N/A	72"
Dieu	144"	120"	96"	96"	108"	84"	96"	60"	108"	60"	30"	60"	48"	72"
Georgie	144"	120"	96"	72"	108"	72"	96"	60"	108"	60"	30"	60"	48"	72"
Hanoi	144"	120"	N/A	94"	108"	84"	96"	60"	108"	60"	30"	60"	48"	72"
Jambu	144"	120"	96"	96"	108"	84"	96"	60"	108"	60"	30"	60"	48"	72"
Jilin	144"	120"	96"	96"	108"	84"	96"	60"	108"	60"	30"	60"	48"	72"
Kaila	144"	120"	96"	72"	108"	72"	96"	60"	108"	60"	30"	60"	48"	72"
Kaliko	144"	120"	96"	96"	108"	84"	96"	N/A	N/A	N/A	N/A	N/A	N/A	N/A
Karina	144"	120"	96"	96"	108"	84"	96"	N/A	N/A	N/A	N/A	N/A	N/A	N/A
Kato	144"	120"	96"	96"	108"	84"	96"	N/A	N/A	N/A	N/A	N/A	N/A	72"
Keani	144"	120"	96"	96"	108"	84"	96"	N/A	N/A	N/A	N/A	N/A	N/A	N/A
Kwan	144"	120"	96"	96"	108"	84"	96"	60"	108"	60"	30"	60"	48"	72"
Lani	144"	120"	96"	96"	108"	84"	96"	60"	108"	60"	30"	60"	48"	72"
Lea	144"	120"	96"	96"	108"	84"	96"	60"	108"	60"	30"	60"	48"	72"
Malana	144"	120"	96"	96"	108"	84"	96"	60"	108"	60"	30"	60"	48"	N/A
Mayli	144"	120"	96"	96"	108"	84"	96"	N/A	N/A	N/A	N/A	N/A	N/A	72"
Meeka	144"	120"	96"	96"	108"	84"	96"	N/A	N/A	N/A	N/A	N/A	N/A	N/A
Miya	144"	120"	96"	96"	108"	84"	96"	N/A	N/A	N/A	N/A	N/A	N/A	72"
Naoki	144"	120"	96"	96"	108"	84"	96"	60"	108"	60"	30"	60"	48"	72"
Nara	144"	120"	96"	96"	108"	84"	96"	60"	108"	60"	30"	60"	48"	72"
Okalani	144"	120"	96"	96"	108"	84"	96"	60"	108"	60"	30"	60"	48"	N/A
Sapporo	144"	120"	96"	96"	108"	84"	96"	N/A	N/A	N/A	N/A	N/A	N/A	N/A
Sasarido	144"	120"	96"	96"	108"	84"	96"	60"	108"	60"	30"	60"	48"	72"
Sibu	144"	120"	N/A	96"	108"	96"	96"	60"	108"	60"	30"	60"	48"	72"
Srilanka	144"	120"	96"	96"	108"	84"	96"	N/A	N/A	N/A	N/A	N/A	N/A	72"
Ulani	144"	120"	96"	96"	108"	84"	96"	60"	108"	60"	30"	60"	48"	72"
Waja	144"	120"	96"	96"	108"	84"	96"	60"	108"	60"	30"	60"	48"	72"
Zaru	144"	120"	96"	96"	108"	84"	96"	60"	108"	60"	30"	60"	48"	72"
Zuki	144"	120"	96"	96"	108"	84"	96"	60"	108"	60"	30"	60"	48"	72"
	Min Width	Min Height	Min Height	Min Width	Min Height	Min Width	Min Height	Min Width	Min Height	Min Width	Min Height	Min Width	Min Height	Min Width
<b>Minimums</b>	45"	30"	30"	24"	30"	15"	30"	15"	30"	12"	6"	12"	12"	15"

## Size Standards - Roman Shades - Cornices

Pattern	Straight Cornice		Railroaded Cornice		Hobbled Cornice	
	Max Width	Max Height	Max Width	Max Height	Max Width	Max Height
Akela	120"	12"	120"	12"	118"	24"
Aris	120"	12"	120"	12"	118"	24"
Bacopa	120"	12"	N/A	N/A	N/A	N/A
Batang	120"	12"	120"	12"	96"	24"
Bayani	120"	12"	120"	12"	96"	24"
Beijing	120"	12"	120"	12"	118"	24"
Caracas	120"	12"	N/A	N/A	72"	24"
Chakra	120"	12"	N/A	N/A	118"	24"
Chinda	120"	12"	120"	12"	118"	24"
Dieu	120"	12"	120"	12"	96"	24"
Georgie	120"	12"	120"	12"	N/A	N/A
Hanoi	120"	12"	120"	12"	N/A	N/A
Jambu	120"	12"	120"	12"	118"	24"
Jilin	120"	12"	120"	12"	118"	24"
Kaila	120"	12"	N/A	N/A	72"	24"
Kaliko	120"	12"	120"	12"	96"	24"
Karina	120"	12"	120"	12"	96"	24"
Kato	120"	12"	120"	12"	96"	24"
Keani	120"	12"	120"	12"	96"	24"
Kwan	120"	12"	120"	12"	96"	24"
Lani	120"	12"	120"	12"	96"	24"
Lea	120"	12"	120"	12"	118"	24"
Malana	120"	12"	120"	12"	96"	24"
Mayli	120"	12"	120"	12"	96"	24"
Meeka	120"	12"	120"	12"	96"	24"
Miya	120"	12"	120"	12"	118"	24"
Naoki	120"	12"	N/A	N/A	118"	24"
Nara	120"	12"	120"	12"	96"	24"
Okalani	120"	12"	120"	12"	118"	24"
Sapporo	120"	12"	N/A	N/A	96"	24"
Sasarido	120"	12"	120"	12"	118"	24"
Sibu	120"	12"	N/A	N/A	N/A	N/A
Srilanka	120"	12"	N/A	N/A	96"	24"
Ulani	120"	12"	120"	12"	96"	24"
Waja	120"	12"	120"	12"	118"	24"
Zaru	120"	12"	120"	12"	96"	24"
Zuki	120"	12"	N/A	N/A	96"	24"
	<b>Min Width</b>	<b>Min Height</b>	<b>Min Width</b>	<b>Min Height</b>	<b>Min Width</b>	<b>Min Height</b>
<b>Minimums</b>	15"	7"	15"	7"	15"	12"

## Size Standards - Panel Track, Panel Drape, & Grommet Panel

Pattern	Panel Track		Panel Drape		Stationary Grommet Panel
	Max Width	Max Height*	Max Width	Max Height	Max Height
Akela	N/A	N/A	120"	118"	94"
Aris	144"	108"/96"	120"	118"	94"
Bacopa	N/A	N/A	N/A	N/A	N/A
Batang	N/A	N/A	120"	94"	94"
Bayani	144"	108"/96"	120"	94"	94"
Beijing	N/A	N/A	120"	118"	94"
Caracas	N/A	N/A	N/A	N/A	N/A
Chakra	N/A	N/A	N/A	N/A	N/A
Chinda	N/A	N/A	120"	118"	94"
Dieu	N/A	N/A	120"	94"	94"
Georgie	N/A	N/A	120"	70"	70"
Hanoi	144"	108"/96"	120"	94"	94"
Jambu	144"	108"/96"	120"	118"	94"
Jilin	144"	108"/96"	120"	118"	94"
Kaila	N/A	N/A	120"	70"	70"
Kaliko	N/A	N/A	120"	94"	94"
Karina	N/A	N/A	120"	94"	94"
Kato	N/A	N/A	120"	94"	94"
Keani	N/A	N/A	120"	94"	N/A
Kwan	N/A	N/A	120"	94"	94"
Lani	N/A	N/A	120"	94"	94"
Lea	N/A	N/A	120"	118"	94"
Malana	N/A	N/A	120"	94"	94"
Mayli	N/A	N/A	120"	94"	N/A
Meeka	N/A	N/A	120"	94"	N/A
Miya	144"	108"/96"	120"	118"	94"
Naaki	N/A	N/A	N/A	N/A	N/A
Nara	144"	108"/96"	120"	94"	94"
Okalani	N/A	N/A	120"	118"	94"
Sapporo	N/A	N/A	N/A	N/A	N/A
Sasarido	N/A	N/A	120"	118"	94"
Sibu	N/A	N/A	N/A	N/A	N/A
Srilanka	N/A	N/A	N/A	N/A	N/A
Ulani	144"	108"/96"	120"	94"	94"
Waja	144"	108"/96"	120"	118"	94"
Zaru	144"	108"/96"	120"	94"	94"
Zuki	N/A	N/A	N/A	N/A	N/A
	<b>27</b>	<b>24/39</b>	<b>36</b>	<b>24</b>	<b>24</b>
<b>Minimums</b>	27"	*24" / 39"	36"	24"	24"

\* Cord Draw Max. Length: 108", Cord Draw Min. Length: 24". Wand Draw Max. Length: 96", Wand Draw Min. Length: 39"

\*\* Cannot have Bottom Banding due to flaring

\*\*\* Max track width is 144". For windows greater than 144", tracks may be butted but panels will not meet.

# Design Options

Lift System Availability	Flat Roman	Hobbled Roman	Duo Shade	Panel Track	Panel Drape	Angle Top Shade	Arch Top Shade
Clutch	Y	Y	N/A	N/A	N/A	N/A	N/A
Cordlock - Traditional	Y	Y	Y	N/A	N/A	Y	Y
Cordlock - Contemporary	Y	Y	Y	N/A	N/A	Y	Y
CareRING Cordless	Y	Y	N/A	N/A	N/A	N/A	N/A
System II	Y	Y	N/A	N/A	N/A	N/A	N/A
R28 WireFree	Y	Y	N/A	N/A	N/A	N/A	N/A
Sonessa 30 WireFree	Y	Y	N/A	N/A	N/A	N/A	N/A
Ultra 30 WireFree	Y	Y	N/A	N/A	N/A	N/A	N/A
EZ Charge V.2	Y	Y	N/A	N/A	N/A	N/A	N/A
EZ Charge X2	Y	Y	N/A	N/A	N/A	N/A	N/A
EZ Charge X3	Y	Y	N/A	N/A	N/A	N/A	N/A
Auto-Wand	Y	Y	N/A	N/A	N/A	N/A	N/A

[Click for Easy Search View](#)

Options Availability	Clutch	Cordlock Traditional	Cordlock Contemporary	CareRING	Flat Roman	Hobbled Roman	Duo Shade	Panel Track	Panel Drape	Stationary Grommet	Angle Top Shade	Arch Top Shade	Arch/ Angle/ Framed
<b>No Charge Options</b>													
Bead Chain Color Substitution	Y	N/A	N/A	N/A	Y	Y	N/A	N/A	N/A	N/A	N/A	N/A	N/A
Bead Chain Optional Length	Y	N/A	N/A	N/A	Y	Y	N/A	N/A	N/A	N/A	N/A	N/A	N/A
Cord Optional Length	N/A	Y	Y	N/A	Y	Y	Y	N/A	N/A	N/A	Y	Y	N/A
Hold Down Brackets	Y	Y	Y	Y	Y	Y	Y	N/A	N/A	N/A	Y	Y	N/A
New York Brackets	N/A	Y	Y	N/A	Y	Y	Y	N/A	N/A	N/A	N/A	N/A	N/A
Soft Returns	Y	Y	Y	Y	Y	Y	Y	N/A	N/A	N/A	N/A	N/A	N/A
Turned Headrail	N/A	Y	Y	N/A	Y	Y	N/A	N/A	N/A	N/A	N/A	N/A	N/A
Track Color Selection	N/A	N/A	N/A	N/A	N/A	N/A	N/A	Y	Y	N/A	N/A	N/A	N/A
Wood Edge Selection	N/A	N/A	N/A	N/A	N/A	N/A	N/A	N/A	Y	N/A	N/A	N/A	N/A
Panels only	N/A	N/A	N/A	N/A	N/A	N/A	N/A	N/A	Y	Y	N/A	N/A	N/A
<b>Surcharge Options</b>													
FR or Antimicrobial	Y	Y	Y	Y	Y	Y	Y	Y	Y	Y	Y	Y	Y
Edge Banding	Y	Y	Y	Y	Y	Y	Y	STD	Y	STD	Y	Y	N/A
Bottom Banding*	N/A	N/A	N/A	N/A	N/A	N/A	N/A	N/A	Y	Y	N/A	N/A	N/A
Lining	Y	Y	Y	Y+	Y	N/A	N/A	Y	Y	Y	Y	Y	N/A
2-on-1 / 3-on-1 Headrail	Y	Y	Y	Y+	Y	Y	N/A	N/A	N/A	N/A	N/A	N/A	N/A
Top-Down/Bottom-Up	N/A	Y	N/A	N/A	Y	Y	N/A	N/A	N/A	N/A	N/A	N/A	N/A
Straight Trim	Y	Y	Y	Y	Y	Y	Y	N/A	N/A	N/A	Y**	Y**	N/A
Additional Valance Length	Y	Y	Y	Y	Y	Y	Y	N/A	N/A	N/A	Y	Y	N/A
Wood Bottom Hem	Y	Y	Y	N/A	Y	Y	N/A	N/A	N/A	N/A	Y	Y	N/A
Split Draw	N/A	N/A	N/A	N/A	N/A	N/A	N/A	Y	Y	N/A	N/A	N/A	N/A
Wood Pole & Finials	N/A	N/A	N/A	N/A	N/A	N/A	N/A	N/A	Y	N/A	N/A	N/A	N/A
Majesty Wood Valance	N/A	N/A	N/A	N/A	N/A	N/A	N/A	Y	Y	N/A	N/A	N/A	N/A
Noble Wood Valance	N/A	N/A	N/A	N/A	N/A	N/A	N/A	Y	Y	N/A	N/A	N/A	N/A
Light Gap Stop	Y	Y	Y	Y	Y	Y	Y	Y	Y	N/A	N/A	N/A	N/A

\* Some fabrics cannot have bottom banding due to flaring.

\*\* Trim available on shade valance hem only.

+ Flat only

# Finished Dimensions & Mounting Requirements

Flat Roman	Finished Dimensions				Mounting Requirements		
	Inside Mount	Outside Mount					
	Fabric Width/ Board Width	Fabric Width	Traditional Style - Board Width	Contemporary Style - Board Width	Inside Minimum Mounting Depth	Inside Flush Mount	Outside Minimum Flat Vertical Surface
Cordlock	- 1/2"	Ordered Width	Soft Returns:+1 1/2" Structured Returns:+3/4"	Ordered Width	1 1/2"	2"	1 1/2"
Quick Lift Clutch	- 1/2"	Ordered Width	Soft Returns:+1 7/8" Structured Returns:+1 1/8"	Ordered Width	1 1/2"	2 1/2"	1 1/2"
Traditional Clutch	- 1/2"	Ordered Width	Soft Returns:+1 7/8" Structured Returns:+1 1/8"	Ordered Width	1 1/2"	2"	1 1/2"
CareRING Cordless	- 1/2"	Ordered Width	Soft Returns:+1 1/2" Structured Returns:+3/4"	Ordered Width	1 1/2"	2 1/2"	1 9/16"
System II	- 1/2"	Ordered Width	Soft Returns:+1 7/8" Structured Returns:+1 1/8"	Ordered Width	1 1/2"	2 1/2"	1 9/16"
Sonessa 30 WF	- 1/2"	Ordered Width	Soft Returns:+1 7/8" Structured Returns:+1 1/8"	Ordered Width	1 1/2"	2 1/2"	1 9/16"
R28 WireFree	- 1/2"	Ordered Width	Soft Returns:+1 7/8" Structured Returns:+1 1/8"	Ordered Width	1 1/2"	2 1/2"	1 9/16"
Ultra 30 WireFree	- 1/2"	Ordered Width	Soft Returns:+1 7/8" Structured Returns:+1 1/8"	Ordered Width	1 1/2"	2 1/2"	1 9/16"
EZ Charge*	- 1/2"	Ordered Width	Soft Returns:+1 7/8" Structured Returns:+1 1/8"	Ordered Width	1 1/2"	2 1/2"	1 9/16"
Auto-Wand	- 1/2"	Ordered Width	Soft Returns:+1 7/8" Structured Returns:+1 1/8"	N/A	1 1/2"	2 1/2"	1 9/16"

Hobbled Roman	Finished Dimensions				Mounting Requirements		
	Inside Mount	Outside Mount					
	Fabric Width/ Board Width	Fabric Width	Traditional Style - Board Width	Contemporary Style - Board Width	Inside Minimum Mounting Depth	Inside Flush Mount	Outside Minimum Flat Vertical Surface
Cordlock	- 1/2"	Ordered Width	Soft Returns:+1 1/2" Structured Returns:+3/4"	Ordered Width	1 1/2"	2"	1 1/2"
Quick Lift Clutch	- 1/2"	Ordered Width	Soft Returns:+1 7/8" Structured Returns:+1 1/8"	Ordered Width	1 1/2"	2 1/2"	1 1/2"
Traditional Clutch	- 1/2"	Ordered Width	Soft Returns:+1 7/8" Structured Returns:+1 1/8"	Ordered Width	1 1/2"	2"	1 1/2"
CareRING Cordless	- 1/2"	Ordered Width	Soft Returns:+1 1/2"	Ordered Width	1 1/2"	2 1/2"	1 9/16"
System II	- 1/2"	Ordered Width	Soft Returns:+1 7/8" Structured Returns:+1 1/8"	Ordered Width	1 1/2"	2 1/2"	1 9/16"
Sonessa 30 WF	- 1/2"	Ordered Width	Soft Returns:+1 7/8" Structured Returns:+1 1/8"	Ordered Width	1 1/2"	2 1/2"	1 9/16"
R28 WireFree	- 1/2"	Ordered Width	Soft Returns:+1 7/8" Structured Returns:+1 1/8"	Ordered Width	1 1/2"	2 1/2"	1 9/16"
Ultra 30 WireFree	- 1/2"	Ordered Width	Soft Returns:+1 7/8" Structured Returns:+1 1/8"	Ordered Width	1 1/2"	2 1/2"	1 9/16"
EZ Charge*	- 1/2"	Ordered Width	Soft Returns:+1 7/8" Structured Returns:+1 1/8"	Ordered Width	1 1/2"	2 1/2"	1 9/16"
Auto-Wand	- 1/2"	Ordered Width	Soft Returns:+1 7/8" Structured Returns:+1 1/8"	N/A	1 1/2"	2 1/2"	1 9/16"

Duo Shade	Finished Dimensions				Mounting Requirements		
	Inside Mount	Outside Mount					
	Fabric Width/ Board Width	Fabric Width	Traditional Style - Board Width	Contemporary Style - Board Width	Inside Minimum Mounting Depth	Inside Flush Mount	Outside Minimum Flat Vertical Surface
Cordlock	- 1/2"	Ordered Width	Regular Returns:+1 1/2" Structured Returns:+3/4"	Ordered Width	1 1/2"	2"	1 1/2"

# Finished Dimensions & Mounting Requirements

Finished Dimensions						
Panel Track	Inside Mount			Outside Mount		
	Fabric Width	Shade Height	Track Width	Fabric Width	Shade Height	Track Width
Cord Draw	-3/4"	-3/8"	Ordered Width -1/8"	Ordered Width	Ordered Height	Ordered Width +1"
Wand Draw	-1/4"	-3/8"	Ordered Width -1/8"	Ordered Width	Ordered Height	Ordered Width +1/8"

Mounting Requirements			
Panel Track	Inside Minimum Mounting Depth	Inside Flush Mount	Outside Minimum Flat Vertical Surface
3 Channels	1 7/8"	2 1/4"	5/8"
4 Channels	2 1/4"	2 7/8"	5/8"
5 Channels	3"	3 5/8"	5/8"

Finished Dimensions					
Panel Drape	Inside Fabric Width	Inside Shade Height	Outside Fabric Width	Outside Shade Height	Outside Track Width
	-1/8"	-3/8"	Ordered Width	-3/8"	Ordered Width

Mounting Requirements			
Panel Drape	Inside Minimum Mounting Depth	Inside Flush Mount	Outside Minimum Flat Vertical Surface
	1 3/8"	3 5/8"	1 7/8"

Stationary Grommet Panel	Finished Dimensions	
	Flat Panel Width	Panel Height
6 Grommets	32"	Ordered Height
8 Grommets	42"	Ordered Height
12 Grommets	62"	Ordered Height

## Stacking Heights

Stacking Heights	Cordlock - Flat	Cordlock - Hobbled	Clutch - Flat/Hobbled	Cordlock - Duo Shade
30" Shade Drop	9"	---	---	---
36" Shade Drop	---	9 3/4"	9 3/4"	9 3/4"
48" Shade Drop	9 3/4"	10 1/2"	10 1/2"	10 1/2"
60" Shade Drop	---	10 3/4"	10 3/4"	10 3/4"
72" Shade Drop	11"	11"	11"	11"
96" Shade Drop	12 1/2"	13"	13"	13"

\*Stacking height is approximate and will vary based upon material thickness and weight for individual fabrics. GENERAL GUIDELINE ONLY.

# Panel Track - Configurations

	3 Channels					
	One Way Draw			Split Draw		
	Minimum Track Width	Maximum Track Width	# of Overlaps	Minimum Track Width	Maximum Track Width	# of Overlaps
2 Panels	27"	79"	1	---	---	---
3 Panels	39"	117"	2	---	---	---
4 Panels	---	---	---	51"	144"	3

## 3 Channels - One Way Draw

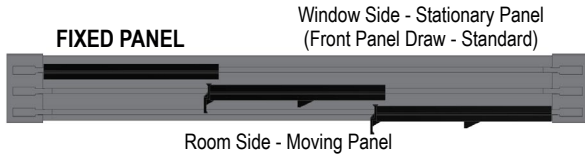

## 3 Channels - Split Draw

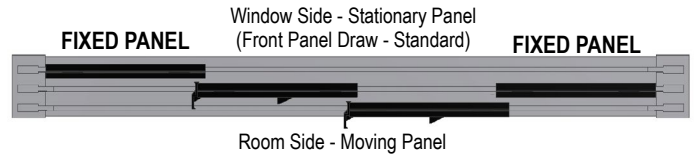

	4 Channels					
	One Way Draw			Split Draw		
	Minimum Track Width	Maximum Track Width	# of Overlaps	Minimum Track Width	Maximum Track Width	# of Overlaps
4 Panels	51"	144"	3	---	---	---
6 Panels	---	---	---	75"	144"	5

## 4 Channels - One Way Draw

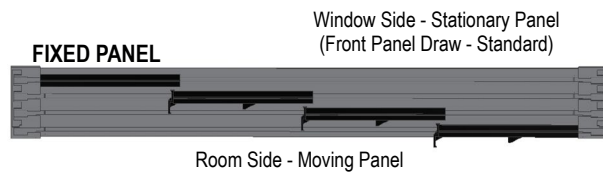

## 4 Channels - Split Draw

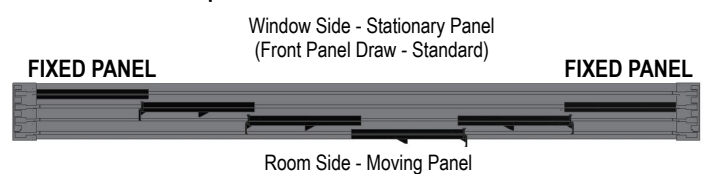

	5 Channels					
	One Way Draw			Split Draw		
	Minimum Track Width	Maximum Track Width	# of Overlaps	Minimum Track Width	Maximum Track Width	# of Overlaps
5 Panels	63"	144"	4	---	---	---
8 Panels	---	---	---	99"	144"	7

## 5 Channels - One Way Draw

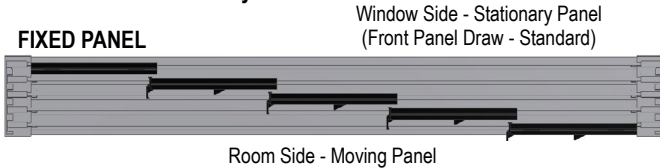

## 5 Channels - Split Draw

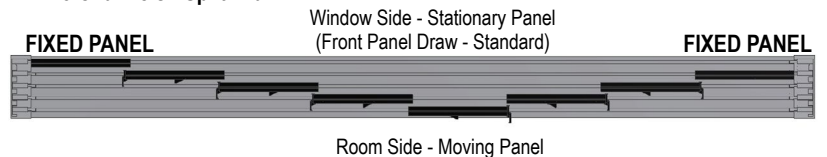



# Panel Track - Configurations

Approximate Panel Size Tables based upon Panels and Overlaps

Panel Width cannot be specified.

Panel Sizes given are approximate and based upon Outside Measure/Mount

		Window Widths					
		2 Panels/ 1 Overlap	3 Panel/ 2 Overlaps	4 Panels/ 3 Overlaps	5 Panels/ 4 Overlaps	6 Panels/ 5 Overlaps (Split Draw Only)	8 Panels/ 7 Overlaps (Split Draw Only)
<b>Panel Widths</b>	15" - 16"	27 - 29"	39" - 42"	51" - 55"	63" - 68"	75" - 81"	99" - 107"
	16 1/16" - 17"	29 1/8" - 31"	42 1/8" - 45"	55 1/8" - 59"	68 1/8" - 73"	81 1/4" - 87"	107 1/4" - 115"
	17 1/16" - 18"	31 1/8" - 33"	45 1/8" - 48"	59 1/8" - 63"	73 1/8" - 78"	87 1/4" - 93"	115 1/4" - 123"
	18 1/16" - 19"	33 1/8" - 35"	48 1/8" - 51"	63 1/8" - 67"	78 1/8" - 83"	93 1/4" - 99"	123 1/4" - 131"
	19 1/16" - 20"	35 1/8" - 37"	51 1/8" - 54"	67 1/8" - 71"	83 1/8" - 88"	99 1/4" - 105"	131 1/4" - 139"
	20 1/16" - 21"	37 1/8" - 39"	54 1/8" - 57"	71 1/8" - 75"	88 1/8" - 93"	105 1/4" - 111"	139 1/4" - 144"
	21 1/16" - 22"	39 1/8" - 41"	57 1/8" - 60"	75 1/8" - 79"	93 1/8" - 98"	111 1/4" - 117"	----
	22 1/16" - 23"	41 1/8" - 43"	60 1/8" - 63"	79 1/8" - 83"	98 1/8" - 103"	117 1/4" - 123"	----
	23 1/16" - 24"	43 1/8" - 45"	63 1/8" - 66"	83 1/8" - 87"	103 1/8" - 108"	123 1/4" - 129"	----
	24 1/16" - 25"	45 1/8" - 47"	66 1/8" - 69"	87 1/8" - 91"	108 1/8" - 113"	129 1/4" - 135"	----
	25 1/16" - 26"	47 1/8" - 49"	69 1/8" - 72"	91 1/8" - 95"	113 1/8" - 118"	135 1/4" - 141"	----
	26 1/16" - 27"	49 1/8" - 51"	72 1/8" - 75"	95 1/8" - 99"	118 1/8" - 123"	141 1/4" - 144"	----
	27 1/16" - 28"	51 1/8" - 53"	75 1/8" - 78"	99 1/8" - 103"	123 1/8" - 128"	----	----
	28 1/16" - 29"	53 1/8" - 55"	78 1/8" - 81"	103 1/8" - 107"	128 1/8" - 133"	----	----
	29 1/16" - 30"	55 1/8" - 57"	81 1/8" - 84"	107 1/8" - 111"	133 1/8" - 138"	----	----
	30 1/16" - 31"	57 1/8" - 59"	84 1/8" - 87"	111 1/8" - 115"	138 1/8" - 144"	----	----
	31 1/16" - 32"	59 1/8" - 61"	87 1/8" - 90"	115 1/8" - 119"	----	----	----
	32 1/16" - 33"	61 1/8" - 63"	90 1/8" - 93"	119 1/8" - 123"	----	----	----
	33 1/16" - 34"	63 1/8" - 65"	93 1/8" - 96"	123 1/8" - 127"	----	----	----
	34 1/16" - 35"	65 1/8" - 67"	96 1/8" - 99"	127 1/8" - 131"	----	----	----
35 1/16" - 36"	67 1/8" - 69"	99 1/8" - 102"	131 1/8" - 135"	----	----	----	
36 1/16" - 37"	69 1/8" - 71"	102 1/8" - 105"	135 1/8" - 139"	----	----	----	
37 1/16" - 38"	71 1/8" - 73"	105 1/8" - 108"	139 1/8" - 144"	----	----	----	
38 1/16" - 39"	73 1/8" - 75"	108 1/8" - 111"	----	----	----	----	
39 1/16" - 40"	75 1/8" - 77"	111 1/8" - 114"	----	----	----	----	
40 1/16" - 41"	77 1/8" - 79"	114 1/8" - 117"	----	----	----	----	

One Way Stacking Width = Panel Width

Split Draw Stacking Width = Panel Width x 2

# Pricing - Manh Truc Flat and Hobbled Roman Shades

FA Flat Roman		Shade Width Up To:								
		24"	30"	36"	42"	48"	60"	72"	84"	96"
Shade Height Up To:	36"	118	145	167	189	214	260	309	356	407
	42"	125	152	176	200	227	278	329	380	434
	48"	132	160	187	212	240	296	349	405	463
	54"	138	169	196	225	254	312	372	429	489
	60"	145	178	207	236	269	329	392	452	516
	66"	154	187	218	249	283	347	412	476	543
	72"	160	196	227	260	296	363	432	500	572
	78"	167	203	238	272	309	380	452	525	598
	84"	174	212	247	285	323	398	474	547	625
	96"	187	229	269	307	349	432	514	596	680
	108"	200	247	289	332	378	465	554	643	734
	120"	214	263	309	356	405	500	596	692	789
HA Hobbled Roman		24"	30"	36"	42"	48"	60"	72"	84"	96"
Shade Height Up To:	36"	145	176	205	234	267	327	389	449	514
	42"	158	194	225	258	292	360	427	496	565
	48"	169	209	245	280	318	392	467	540	618
	54"	183	225	265	303	345	425	505	587	669
	60"	196	240	283	325	369	458	545	632	723
	66"	209	258	303	349	396	489	583	678	774
	72"	223	274	323	372	423	523	623	723	825
	78"	236	289	343	394	449	556	663	767	878
	84"	249	307	360	416	474	587	700	814	929
	96"	274	338	400	463	527	652	778	905	1034

Surcharges	24"	30"	36"	42"	48"	60"	72"	84"	96"
Valance - Ea. Additional 12"	20	27	34	40	43	54	56	65	74
Straight/Railroaded Cornice - Unlined	85	100	114	132	154	185	218	254	292
Straight/Railroaded Cornice - Lined - Light Filtering	174	194	209	236	269	314	358	398	438
Straight/Railroaded Cornice - Lined - Opaque	203	227	247	274	314	360	409	449	494
Hobbled Cornice - Unlined	103	116	136	160	180	220	263	307	352
Hobbled Cornice - Lined - Light Filtering	192	207	232	265	296	352	400	449	498
Hobbled Cornice - Lined - Opaque	220	243	269	303	340	398	454	503	554
Lining - Light Filtering	132	138	147	160	176	196	209	216	223
Lining - Opaque	180	194	203	216	243	265	292	298	307
Lined Valance Only - Light Filtering	94	100	105	114	125	138	149	154	158
Lined Valance Only - Opaque	127	136	145	154	172	187	205	209	216
TLC Cordless System	72	72	76	73	87	94	112	118	N/A

For Additional Surcharges and Options - See page 24  
 For Motorization Surcharges - See pages 25-26

# Pricing - Manh Truc Flat and Hobbled Roman Shades

F1 Flat Roman		Shade Width Up To:										
		24"	30"	36"	42"	48"	60"	72"	84"	96"	108"	118"
Shade Height Up To:	36"	129	158	185	209	238	292	347	400	458	658	720
	42"	138	169	198	225	256	314	374	432	494	714	780
	48"	147	180	209	240	274	336	400	463	529	769	843
	54"	156	192	223	256	292	358	425	494	563	827	905
	60"	165	203	236	272	309	380	452	525	598	883	965
	66"	174	214	249	287	325	403	478	554	634	938	1027
	72"	183	225	263	303	343	425	505	585	669	996	1089
	78"	192	236	276	318	360	445	532	616	703	1052	1149
	84"	200	245	289	332	378	467	558	647	738	1107	1212
	96"	218	267	316	363	414	512	609	707	809	1220	1334
	108"	234	289	343	394	449	556	663	769	878	1332	1456
120"	252	312	367	425	483	600	716	832	949	1445	1580	
H1 Hobbled Roman		24"	30"	36"	42"	48"	60"	72"	84"	96"	108"	118"
Shade Height Up To:	36"	163	198	234	267	303	374	445	516	589	872	954
	42"	178	218	258	296	336	416	496	574	656	976	1069
	48"	194	240	283	325	369	456	545	632	723	1083	1183
	54"	212	260	307	354	403	498	594	689	787	1187	1298
	60"	227	280	332	383	436	538	643	747	854	1294	1414
	66"	245	300	356	412	469	580	694	805	920	1398	1529
	72"	260	323	380	440	500	623	743	863	985	1505	1645
	78"	276	343	405	469	534	663	792	920	1052	1609	1758
	84"	294	363	432	498	567	705	840	978	1118	1714	1874
	96"	327	405	480	556	634	787	940	1094	1249	1925	2105

Surcharges	24"	30"	36"	42"	48"	60"	72"	84"	96"	108"	118"
Valance - Ea. Additional 12"	27	36	43	49	54	65	69	78	89	107	120
Straight/Railroaded Cornice - Unlined	103	120	136	156	180	216	258	298	343	376	423
Straight/Railroaded Cornice - Lined - Light Filtering	205	227	247	278	316	369	420	465	514	556	N/A
Straight/Railroaded Cornice - Lined - Opaque	240	269	292	323	369	423	480	527	578	N/A	N/A
Hobbled Cornice - Unlined	123	138	160	189	212	260	309	360	412	N/A	N/A
Hobbled Cornice - Lined - Light Filtering	225	245	274	312	347	412	472	527	583	N/A	N/A
Hobbled Cornice - Lined - Opaque	260	287	316	356	398	465	532	589	647	N/A	N/A
Lining - Light Filtering	132	138	147	160	176	196	209	216	223	232	N/A
Lining - Opaque	180	194	203	216	243	265	292	298	307	N/A	N/A
Lined Valance Only - Light Filtering	94	100	105	114	125	138	149	154	158	165	N/A
Lined Valance Only - Opaque	127	136	145	154	172	187	205	209	216	N/A	N/A
CareRING Cordless System	72	72	76	73	87	94	112	118	N/A	N/A	N/A

For Additional Surcharges and Options - See page 24  
 For Motorization Surcharges - See pages 25-26

# Pricing - Manh Truc Flat and Hobbled Roman Shades

F2 Flat Roman		Shade Width Up To:										
		24"	30"	36"	42"	48"	60"	72"	84"	96"	108"	118"
Shade Height Up To:	36"	174	212	247	283	323	396	472	547	625	916	1000
	42"	187	227	267	307	347	429	509	592	676	998	1092
	48"	198	245	287	329	374	460	549	636	727	1080	1183
	54"	212	260	305	352	400	494	587	680	778	1163	1272
	60"	225	276	325	374	425	525	625	727	829	1245	1363
	66"	238	292	345	396	452	558	665	772	880	1329	1454
	72"	249	309	363	418	476	589	703	816	932	1412	1543
	78"	263	325	383	440	503	623	740	860	983	1494	1634
	84"	276	340	403	463	527	654	780	905	1036	1576	1723
	96"	303	372	440	509	578	718	856	996	1138	1743	1905
	108"	327	405	478	554	632	783	934	1085	1240	1907	2085
	120"	354	436	518	598	683	847	1012	1176	1343	2072	2265
H2 Hobbled Roman		24"	30"	36"	42"	48"	60"	72"	84"	96"	108"	118"
Shade Height Up To:	36"	214	265	312	358	407	503	600	696	794	1196	1307
	42"	238	294	345	398	454	560	669	778	887	1345	1472
	48"	260	323	380	438	500	620	740	860	983	1496	1636
	54"	285	352	416	480	547	678	809	940	1076	1645	1798
	60"	307	380	452	520	594	736	880	1023	1169	1796	1963
	66"	332	409	487	563	640	796	949	1105	1263	1947	2127
	72"	354	440	520	603	687	854	1020	1187	1356	2096	2292
	78"	378	469	556	645	734	912	1089	1269	1449	2247	2456
	84"	400	498	592	685	780	972	1160	1349	1543	2396	2620
	96"	447	556	660	767	874	1087	1300	1514	1729	2696	2947

Surcharges	24"	30"	36"	42"	48"	60"	72"	84"	96"	108"	118"
Valance - Ea. Additional 12"	45	49	56	65	76	92	114	129	138	163	172
Straight/Railroaded Cornice - Unlined	109	123	140	163	189	232	272	314	363	398	449
Straight/Railroaded Cornice - Lined - Light Filtering	209	232	254	285	325	380	432	480	534	576	N/A
Straight/Railroaded Cornice - Lined - Opaque	347	378	409	449	509	585	654	707	767	576	N/A
Hobbled Cornice - Unlined	129	147	167	200	225	278	325	374	434	N/A	N/A
Hobbled Cornice - Lined - Light Filtering	232	254	278	323	360	429	485	538	605	N/A	N/A
Hobbled Cornice - Lined - Opaque	367	400	434	487	547	632	707	765	838	N/A	N/A
Lining - Light Filtering	132	138	147	160	176	196	209	216	223	232	N/A
Lining - Opaque	180	194	203	216	243	265	292	298	307	N/A	N/A
Lined Valance Only - Light Filtering	94	100	105	114	125	138	149	154	158	165	N/A
Lined Valance Only - Opaque	127	136	145	154	172	187	205	209	216	N/A	N/A
CareRING Cordless System	72	72	76	73	87	94	112	118	N/A	N/A	N/A

For Additional Surcharges and Options - See page 24  
 For Motorization Surcharges - See pages 25-26

# Pricing - Manh Truc Flat and Hobbled Roman Shades

F3 Flat Roman		Shade Width Up To:										
		24"	30"	36"	42"	48"	60"	72"	84"	96"	108"	118"
Shade Height Up To:	36"	205	252	296	340	385	476	567	656	749	1020	1118
	42"	223	272	320	367	418	516	614	714	814	1114	1218
	48"	238	294	345	396	449	556	663	769	878	1207	1320
	54"	254	314	369	425	483	596	712	825	943	1300	1423
	60"	269	334	392	452	514	636	760	883	1007	1394	1525
	66"	287	354	416	480	547	678	807	938	1072	1487	1627
	72"	303	374	440	509	578	718	856	994	1136	1580	1729
	78"	318	394	465	536	612	758	905	1052	1200	1674	1832
	84"	334	414	489	565	643	798	952	1107	1265	1767	1932
	96"	367	454	538	620	707	878	1049	1220	1394	1954	2136
	108"	398	494	585	678	772	958	1145	1332	1523	2140	2340
	120"	432	534	634	734	836	1038	1243	1445	1652	2327	2545
H3 Hobbled Roman		24"	30"	36"	42"	48"	60"	72"	84"	96"	108"	118"
Shade Height Up To:	36"	243	298	352	405	460	572	680	792	905	1254	1369
	42"	269	332	394	454	516	640	763	887	1014	1412	1543
	48"	296	367	434	500	572	709	845	983	1123	1569	1716
	54"	325	400	476	549	625	776	927	1078	1232	1729	1889
	60"	352	436	516	596	680	845	1009	1174	1343	1887	2063
	66"	378	469	556	645	736	914	1092	1272	1452	2045	2236
	72"	407	503	598	694	789	983	1174	1367	1560	2205	2409
	78"	434	538	638	740	845	1052	1256	1463	1672	2363	2583
	84"	460	572	680	789	900	1118	1338	1558	1780	2520	2756
	96"	516	640	763	885	1009	1256	1503	1749	1998	2838	3103

Surcharges	24"	30"	36"	42"	48"	60"	72"	84"	96"	108"	118"
Valance - Ea. Additional 12"	45	52	56	67	76	92	116	132	140	165	176
Straight/Railroaded Cornice - Unlined	114	134	149	183	203	243	292	336	387	429	476
Straight/Railroaded Cornice - Lined - Light Filtering	216	243	263	307	340	396	456	505	560	612	N/A
Straight/Railroaded Cornice - Lined - Opaque	254	285	307	352	394	449	518	567	627	429	N/A
Hobbled Cornice - Unlined	134	156	178	214	240	294	349	400	465	N/A	N/A
Hobbled Cornice - Lined - Light Filtering	238	265	292	338	378	447	512	569	638	N/A	N/A
Hobbled Cornice - Lined - Opaque	274	307	336	383	429	503	574	632	703	N/A	N/A
Lining - Light Filtering	132	138	147	160	176	196	209	216	223	232	N/A
Lining - Opaque	180	194	203	216	243	265	292	298	307	N/A	N/A
Lined Valance Only - Light Filtering	94	100	105	114	125	138	149	154	158	165	N/A
Lined Valance Only - Opaque	127	136	145	154	172	187	205	209	216	N/A	N/A
CareRING Cordless System	72	72	76	73	87	94	112	118	N/A	N/A	N/A

For Additional Surcharges and Options - See page 24  
 For Motorization Surcharges - See pages 25-26

# Pricing - Manh Truc Flat and Hobbled Roman Shades

F4 Flat Roman		Shade Width Up To:										
		24"	30"	36"	42"	48"	60"	72"	84"	96"	108"	118"
Shade Height Up To:	36"	223	274	323	369	420	520	618	718	820	1127	1234
	42"	240	296	349	403	458	565	674	783	894	1234	1349
	48"	258	320	376	434	494	612	729	845	967	1340	1465
	54"	278	343	405	465	529	656	783	909	1040	1445	1580
	60"	296	365	432	498	567	703	838	974	1112	1552	1696
	66"	314	387	458	529	603	749	894	1038	1185	1658	1814
	72"	332	412	487	563	640	794	947	1103	1258	1765	1929
	78"	352	434	514	594	676	840	1003	1165	1332	1872	2045
	84"	369	456	540	625	714	885	1058	1229	1405	1976	2160
	96"	405	503	596	689	787	976	1167	1358	1552	2189	2394
	108"	443	547	652	754	860	1069	1278	1487	1698	2403	2625
	120"	478	594	705	818	934	1160	1387	1614	1845	2614	2858
H4 Hobbled Roman		24"	30"	36"	42"	48"	60"	72"	84"	96"	108"	118"
Shade Height Up To:	36"	276	343	405	467	532	658	787	914	1045	1458	1594
	42"	309	383	454	523	596	740	885	1027	1174	1647	1800
	48"	343	423	503	580	663	823	983	1143	1305	1836	2007
	54"	374	465	552	638	727	903	1080	1256	1434	2025	2214
	60"	407	505	600	694	792	985	1176	1369	1565	2214	2418
	66"	440	545	649	752	856	1065	1274	1483	1694	2400	2625
	72"	472	585	696	809	923	1147	1372	1598	1825	2589	2832
	78"	505	627	745	865	987	1229	1469	1712	1956	2778	3038
	84"	536	667	794	923	1052	1309	1567	1825	2085	2967	3243
	96"	603	749	892	1036	1183	1472	1763	2052	2345	3345	3656

Surcharges	24"	30"	36"	42"	48"	60"	72"	84"	96"	108"	118"
Valance - Ea. Additional 12"	47	56	67	74	83	114	127	145	158	180	200
Straight/Railroaded Cornice - Unlined	116	134	152	185	205	254	292	345	392	434	483
Straight/Railroaded Cornice - Lined - Light Filtering	218	240	263	307	340	403	452	509	560	612	N/A
Straight/Railroaded Cornice - Lined - Opaque	254	280	307	349	392	456	514	572	625	434	N/A
Hobbled Cornice - Unlined	134	158	185	220	243	303	347	416	467	N/A	N/A
Hobbled Cornice - Lined - Light Filtering	236	267	296	343	378	452	507	583	638	N/A	N/A
Hobbled Cornice - Lined - Opaque	272	307	340	385	429	505	569	643	700	N/A	N/A
Lining - Light Filtering	132	138	147	160	176	196	209	216	223	232	N/A
Lining - Opaque	180	194	203	216	243	265	292	298	307	N/A	N/A
Lined Valance Only - Light Filtering	94	100	105	114	125	138	149	154	158	165	N/A
Lined Valance Only - Opaque	127	136	145	154	172	187	205	209	216	N/A	N/A
CareRING Cordless System	72	72	76	73	87	94	112	118	N/A	N/A	N/A

For Additional Surcharges and Options - See page 24  
 For Motorization Surcharges - See pages 25-26

# Pricing - Manh Truc Flat and Hobbled Roman Shades

F5 Flat Roman		Shade Width Up To:										
		24"	30"	36"	42"	48"	60"	72"	84"	96"	108"	118"
Shade Height Up To:	36"	243	300	354	407	465	576	687	796	909	1227	1340
	42"	265	327	385	445	507	629	752	872	996	1347	1474
	48"	285	354	418	483	549	683	816	947	1083	1467	1605
	54"	307	380	452	520	594	736	880	1023	1167	1587	1736
	60"	329	407	483	558	636	789	945	1098	1254	1707	1867
	66"	349	434	516	596	678	845	1009	1174	1340	1829	1998
	72"	372	460	547	634	723	898	1074	1247	1425	1949	2129
	78"	394	487	580	672	765	952	1138	1323	1512	2069	2263
	84"	414	514	612	709	807	1005	1203	1398	1598	2189	2394
	96"	458	569	676	785	894	1112	1332	1549	1769	2429	2656
	108"	500	623	740	858	980	1220	1460	1700	1943	2672	2918
120"	545	676	805	934	1067	1327	1589	1849	2114	2912	3183	
H5 Hobbled Roman		24"	30"	36"	42"	48"	60"	72"	84"	96"	108"	118"
Shade Height Up To:	36"	307	380	452	523	596	740	885	1029	1176	1603	1754
	42"	347	429	509	589	674	836	1000	1163	1329	1816	1985
	48"	385	476	567	656	749	932	1114	1296	1480	2029	2218
	54"	423	525	625	723	825	1027	1229	1429	1634	2243	2452
	60"	460	572	680	789	900	1123	1343	1563	1787	2456	2685
	66"	498	620	738	856	978	1218	1456	1696	1938	2669	2918
	72"	536	667	796	923	1054	1312	1572	1829	2092	2883	3149
	78"	574	714	852	989	1129	1407	1685	1963	2243	3096	3383
	84"	614	763	909	1056	1207	1503	1800	2096	2396	3309	3616
	96"	689	858	1025	1189	1358	1694	2029	2363	2700	3736	4083

Surcharges	24"	30"	36"	42"	48"	60"	72"	84"	96"	108"	118"
Valance - Ea. Additional 12"	56	67	78	83	105	129	147	167	198	220	245
Straight/Railroaded Cornice - Unlined	123	143	160	194	216	269	316	367	423	467	523
Straight/Railroaded Cornice - Lined - Light Filtering	225	249	274	316	352	420	478	534	596	647	N/A
Straight/Railroaded Cornice - Lined - Opaque	260	292	316	360	403	474	538	596	658	467	N/A
Hobbled Cornice - Unlined	145	167	194	229	260	320	376	438	507	N/A	N/A
Hobbled Cornice - Lined - Light Filtering	247	276	305	352	396	472	536	605	680	N/A	N/A
Hobbled Cornice - Lined - Opaque	283	316	349	396	447	525	598	667	743	N/A	N/A
Lining - Light Filtering	132	138	147	160	176	196	209	216	223	232	N/A
Lining - Opaque	180	194	203	216	243	265	292	298	307	N/A	N/A
Lined Valance Only - Light Filtering	94	100	105	114	125	138	149	154	158	165	N/A
Lined Valance Only - Opaque	127	136	145	154	172	187	205	209	216	N/A	N/A
CareRING Cordless System	72	72	76	73	87	94	112	118	N/A	N/A	N/A

For Additional Surcharges and Options - See page 24  
 For Motorization Surcharges - See pages 25-26

# Pricing - Manh Truc Flat and Hobbled Roman Shades

F6 Flat Roman		Shade Width Up To:								
		24"	30"	36"	42"	48"	60"	72"	84"	96"
Shade Height Up To:	36"	276	340	403	465	529	656	783	909	1038
	42"	300	372	440	507	578	718	856	996	1138
	48"	325	403	476	552	629	780	932	1085	1238
	54"	349	434	514	596	678	843	1007	1172	1338
	60"	376	465	552	638	729	905	1083	1258	1438
	66"	400	496	589	683	778	967	1158	1347	1538
	72"	425	527	627	727	829	1032	1232	1434	1638
	78"	449	558	665	772	878	1094	1307	1523	1738
	84"	476	589	703	814	929	1156	1383	1609	1838
	96"	525	654	778	903	1029	1280	1534	1785	2038
	108"	576	716	852	989	1129	1407	1683	1960	2240
	120"	625	778	927	1076	1229	1532	1834	2136	2440
H6 Hobbled Roman		24"	30"	36"	42"	48"	60"	72"	84"	96"
Shade Height Up To:	36"	345	427	507	587	672	834	996	1160	1325
	42"	389	483	574	665	758	943	1127	1312	1498
	48"	432	536	638	740	845	1052	1258	1465	1674
	54"	476	592	703	816	932	1160	1387	1616	1847
	60"	518	645	769	894	1018	1269	1518	1769	2020
	66"	563	700	834	969	1105	1378	1649	1920	2196
	72"	607	754	900	1045	1194	1487	1780	2074	2369
	78"	649	809	965	1120	1280	1596	1909	2225	2543
	84"	694	863	1029	1198	1367	1705	2040	2378	2718
	96"	780	972	1160	1349	1540	1920	2303	2683	3065

Surcharges	24"	30"	36"	42"	48"	60"	72"	84"	96"
Valance - Ea. Additional 12"	65	72	85	103	120	138	163	196	220
Straight/Railroaded Cornice - Unlined	127	149	169	205	229	285	329	380	436
Straight/Railroaded Cornice - Lined - Light Filtering	229	258	285	329	367	438	492	549	609
Straight/Railroaded Cornice - Lined - Opaque	267	300	329	374	420	492	554	612	674
Hobbled Cornice - Unlined	149	178	207	240	276	338	396	458	520
Hobbled Cornice - Lined - Light Filtering	254	287	320	365	414	492	560	627	696
Hobbled Cornice - Lined - Opaque	289	329	365	409	467	547	623	689	760
Lining - Light Filtering	132	138	147	160	176	196	209	216	223
Lining - Opaque	180	194	203	216	243	265	292	298	307
Lined Valance Only - Light Filtering	94	100	105	114	125	138	149	154	158
Lined Valance Only - Opaque	127	136	145	154	172	187	205	209	216
CareRING Cordless System	72	72	76	73	87	94	112	118	N/A

For Additional Surcharges and Options - See page 24  
 For Motorization Surcharges - See pages 25-26



# Pricing - Duo Shade Lining & Additional Option Surcharges

L1 - Light Filtering		Shade Width Up To:							
		24"	30"	36"	42"	48"	60"	72"	84"
Shade Height Up To:	36"	85	107	116	134	145	178	207	243
	42"	103	120	134	156	172	205	247	278
	48"	109	127	136	160	174	209	252	289
	54"	114	136	154	180	196	238	280	320
	60"	127	154	174	200	218	265	314	363
	66"	138	172	192	223	243	294	349	398
	72"	147	174	194	225	249	298	354	407
	78"	154	192	209	249	267	325	385	443
	84"	169	205	229	267	294	356	418	483
	96"	185	225	252	294	316	385	456	525
L2 - Opaque		24"	30"	36"	42"	48"	60"	72"	84"
Shade Height Up To:	36"	114	136	156	185	203	249	294	340
	42"	129	160	180	207	229	280	338	387
	48"	134	167	187	218	243	296	352	407
	54"	149	185	209	249	272	334	394	456
	60"	169	205	232	272	303	369	438	505
	66"	185	225	258	298	334	405	480	554
	72"	192	232	263	309	340	416	496	574
	78"	205	254	289	336	369	454	536	620
	84"	223	272	309	363	398	492	580	672
	96"	243	298	340	396	440	540	636	738

Optional Surcharges	24"	30"	36"	42"	48"	60"	72"	84"	96"	108"	118"
Wood Bottom Hem	40	45	52	54	58	65	69	N/A	N/A	N/A	N/A
Straight Trim/Gimp (per row)	38	43	47	52	58	69	74	85	109	132	156
Top-Down/Bottom-Up	63	67	74	87	94	109	118	127	138	152	N/A
Metal Bead Chain - Clutch	23										
Twill or Fabric Banding on 2 Edges	185										
Twill or Fabric Banding on 3 or 4 Edges	243										
2-on-1 Headrail (add to base price of 2 shades added together)	74										
3-on-1 Headrail (add to base price of 3 shades added together)	112										
Mitred Headrail	54										
Angle Top / Arch Top	247										
Light Gap Stop (Per Ft.)	3										
Palladian Shelf - Finished (Per Ft.)	28										
Palladian Shelf - Unfinished (Per Ft.)	23										

Arch Surcharges (add to price at max height and max width)			
Standard Arch	154		
Width To:	36"	48"	60"
Framed Arch	543	634	723
Routed Framed Arch	743	832	920

# Pricing - Motorization

<b>System II (Battery) Motorization Surcharges</b>	<b>Item #</b>	<b>Surcharge</b>
Radio Frequency 12V (motor only)	1240292 + 9020674	\$306
Radio Frequency 12V Motor Assembly (Reloadable Battery Wand, Lithium Batteries, Mounting Clips)	1240292 + 9020674 + 9014020 + 29-81153	463
Radio Frequency 12V Motor Assembly (Mounting Clips, Solar Pack)	1240292 + 9020674 + 9019034 + 9018621	601
Radio Frequency 12V Motor Assembly (12V DC Transformer, 10' cord)	1240292 + 9020674 + 1822445	511
Radio Frequency 12V Motor Assembly (Rechargeable li-ion battery pack)	1240292 + 9020674 + 9021217	418

<b>Somfy Rechargeable Motorization Surcharges</b>	<b>Item #</b>	<b>Surcharge</b>
R28 WireFree Motor	1240291 + 9020674	\$245
Sonesse 30 WireFree Motor	1003128 + 9020674	324
Ultra 30 WireFree Motor	1003310 + 9020674	336

<b>Somfy Rechargeable Accessories Surcharges</b>	<b>Item #</b>	<b>Surcharge</b>
Sonesse 30/R28 WireFree Charger 5ft	9020672	\$31
Sonesse 30 WireFree/R28 WireFree 96" Extension Cable	9020673	10
ULTRA 30 WireFree/Rechargeable Battery Pack Charger 5ft	9025166	31
ULTRA 30 WireFree/ Rechargeable Battery Pack 94.5" Extension Cable	9021016	10
ULTRA 30 WireFree/ Rechargeable Battery Pack Lead Cable 8"	9021131	10

<b>Somfy Controls and Accessories</b>	<b>Item #</b>	<b>Surcharge</b>
Single Channel Situo RF Transmitter (White), per transmitter	1800128	\$96
Five Channel Situo RF Transmitter (White), per transmitter	1800139	132
Single Channel Modulis RF Transmitter (White), per transmitter	1811234	223
Five Channel Modulis RF Transmitter (White), per transmitter	1811235	291
Single Channel Telis RF Transmitter (White), per transmitter	1810632	104
Single Channel Telis RF Transmitter (Black,Silver), per transmitter	1810639 (Silver), 1810650 (Black)	162
Five Channel Telis RF Transmitter (White), per transmitter	1810633	135
Five Channel Telis RF Transmitter (Black,Silver), per transmitter	1810641 (Silver), 1810652 (Black)	195
Sixteen Channel Telis RF Transmitter ( White), per transmitter	1811081	498
Sixteen Channel Telis RF Transmitter (Silver), per transmitter	1811082	527
Single Channel Decoflex Wall Switch (White, Ivory)	1810897 (White), 1810898 (Ivory)	257
Single Channel Decoflex Wall Switch (Black)	1810899 (Black)	310
Five Channel Decoflex Wall Switch (White, Ivory)	1810813 (White), 1810814 (Ivory)	266
Five Channel Decoflex Wall Switch (Black)	1810830 (Black)	317
4' Extension Wire *	9016736	24
8' Extension Wire *	9018624	26
myLink	1811264	421
Rechargeable Li-Ion Battery Pack	9021217	112

\* Required on Motor Only

# Pricing - Motorization

<b>EZ Charge Motorization Surcharges</b>	Item #	Surcharge
EZ Charge V2 Rechargeable Motorization	MTDCBRF25-1-1 + MTCRDR-25-1-5	\$346
EZ Charge X2 Rechargeable Motorization	MTDCBRFQ28-2 + MTCRDR-28-15	445
EZ Charge X3 Rechargeable Motorization	MTDCBRFQ45-3 + MTCRDR45-2-5	579

<b>EZ Charge Motorization Surcharges</b>	Item #	Surcharge
12' Charger - One Charger required per order - sold separately	MTDCB-CHARGE	\$49
15 Channel Remote Control - One Remote required per order - sold separately	MTRF-REM-15NL	110
5 Channel Surface Mount Wireless Wall Switch	MTRF-WS5-FLUSH	84
Pulse Bridge Kit	MTRF-WIFIBRD	354
48" extension cable	MTDCB-CBLXT48	17
96" extension cable	MTDCB-CBLXT96	24
Pulse Bridge Serial Cable (for 3rd party serial connection)	MTSER-BASE-KIT	101
Sun Sensor	MTRF-SUNSENS	68
Solar Panel	MTSOLPAN-B	269
ARC Repeater	MT02-0401-05	147
Rechargeable Battery Pack	MTBPCR-28	173

<b>Auto-Wand V2. Motorization Surcharges</b>	Item #	Surcharge
Battery Operated Wand Control Motorization (any width) - Version 2.0	MTDCBSW25-1-1 + MTCRDR-25-1-5	\$195
6' Micro USB Charger - sold separately	MTPS-USBCABLE	26

# Pricing - Manh Truc Panel Track

PT1 Panel Track		Shade Width Up To:								
		48"	60"	72"	84"	96"	108"	120"	132"	144"
Shade Height Up To:	48"	369	449	529	609	692	772	852	932	1014
	60"	420	514	607	700	794	887	980	1072	1165
	72"	472	578	683	789	896	1000	1107	1214	1318
	84"	523	640	760	878	998	1116	1236	1354	1472
	96"	574	705	836	967	1100	1232	1363	1494	1625
	108"	625	769	914	1058	1203	1345	1489	1634	1778
<b>Surcharges</b>		<b>48"</b>	<b>60"</b>	<b>72"</b>	<b>84"</b>	<b>96"</b>	<b>108"</b>	<b>120"</b>	<b>132"</b>	<b>144"</b>
Straight/Railroaded Cornice - Unlined		205	245	289	336	385	423	476	N/A	N/A
Straight/Railroaded Cornice - Lined - Light Filtering		358	416	474	525	576	623	N/A	N/A	N/A
Straight/Railroaded Cornice - Lined - Opaque		416	476	540	594	652	N/A	N/A	N/A	N/A
Hobbled Cornice - Unlined		240	294	347	405	463	N/A	N/A	N/A	N/A
Hobbled Cornice - Lined - Light Filtering		392	463	529	594	656	N/A	N/A	N/A	N/A
Hobbled Cornice - Lined - Opaque		447	525	598	663	727	N/A	N/A	N/A	N/A

PT2 Panel Track		Shade Width Up To:								
		48"	60"	72"	84"	96"	108"	120"	132"	144"
Shade Height Up To:	48"	394	480	567	654	740	827	914	998	1085
	60"	452	552	652	752	854	954	1054	1156	1256
	72"	507	623	736	852	967	1080	1196	1312	1425
	84"	565	694	823	952	1080	1209	1338	1467	1596
	96"	620	763	907	1049	1194	1336	1480	1623	1767
	108"	678	834	992	1149	1307	1465	1620	1778	1936
<b>Surcharges</b>		<b>48"</b>	<b>60"</b>	<b>72"</b>	<b>84"</b>	<b>96"</b>	<b>108"</b>	<b>120"</b>	<b>132"</b>	<b>144"</b>
Straight/Railroaded Cornice - Unlined		216	263	309	358	414	452	509	N/A	N/A
Straight/Railroaded Cornice - Lined - Light Filtering		369	434	492	545	607	656	N/A	N/A	N/A
Straight/Railroaded Cornice - Lined - Opaque		578	665	740	800	874	656	N/A	N/A	N/A
Hobbled Cornice - Unlined		258	318	369	425	494	N/A	N/A	N/A	N/A
Hobbled Cornice - Lined - Light Filtering		412	487	552	612	687	N/A	N/A	N/A	N/A
Hobbled Cornice - Lined - Opaque		620	718	800	867	954	N/A	N/A	N/A	N/A

For Additional Surcharges and Options - See page 29

# Pricing - Manh Truc Panel Track

PT3 Panel Track		Shade Width Up To:								
		48"	60"	72"	84"	96"	108"	120"	132"	144"
Shade Height Up To:	48"	427	520	616	709	805	898	994	1089	1183
	60"	492	600	712	823	934	1043	1154	1265	1376
	72"	554	680	807	934	1060	1187	1316	1443	1569
	84"	618	760	905	1047	1189	1332	1476	1618	1760
	96"	683	843	1000	1158	1318	1476	1636	1794	1954
	108"	747	923	1096	1272	1447	1620	1796	1972	2147
Surcharges		48"	60"	72"	84"	96"	108"	120"	132"	144"
Straight/Railroaded Cornice - Unlined		232	278	334	385	443	492	545	N/A	N/A
Straight/Railroaded Cornice - Lined - Light Filtering		389	452	520	576	640	696	N/A	N/A	N/A
Straight/Railroaded Cornice - Lined - Opaque		449	514	589	647	716	492	N/A	N/A	N/A
Hobbled Cornice - Unlined		274	336	398	458	532	N/A	N/A	N/A	N/A
Hobbled Cornice - Lined - Light Filtering		432	512	585	649	732	N/A	N/A	N/A	N/A
Hobbled Cornice - Lined - Opaque		492	574	658	723	805	N/A	N/A	N/A	N/A

PT4 Panel Track		Shade Width Up To:								
		48"	60"	72"	84"	96"	108"	120"	132"	144"
Shade Height Up To:	48"	452	554	654	756	856	958	1060	1160	1263
	60"	523	643	760	878	998	1118	1236	1356	1474
	72"	594	729	867	1003	1140	1276	1414	1549	1687
	84"	665	818	972	1127	1280	1436	1589	1743	1898
	96"	734	907	1078	1249	1423	1594	1767	1938	2109
	108"	805	994	1185	1374	1563	1754	1943	2132	2323
Surcharges		48"	60"	72"	84"	96"	108"	120"	132"	144"
Straight/Railroaded Cornice - Unlined		245	300	347	412	465	518	576	N/A	N/A
Straight/Railroaded Cornice - Lined - Light Filtering		405	480	538	607	667	729	N/A	N/A	N/A
Straight/Railroaded Cornice - Lined - Opaque		465	545	614	683	745	518	N/A	N/A	N/A
Hobbled Cornice - Unlined		289	358	414	498	558	N/A	N/A	N/A	N/A
Hobbled Cornice - Lined - Light Filtering		452	538	605	694	760	N/A	N/A	N/A	N/A
Hobbled Cornice - Lined - Opaque		512	600	680	765	836	N/A	N/A	N/A	N/A

For Additional Surcharges and Options - See page 29

# Pricing - Manh Truc Panel Track

Lining Surcharges - Light Filtering		Shade Width Up To:								
		48"	60"	72"	84"	96"	108"	120"	132"	144"
Shade Height Up To:	48"	134	160	183	212	238	276	303	327	352
	60"	160	196	227	256	287	334	363	403	427
	72"	183	227	260	300	338	392	427	467	505
	84"	214	258	300	343	387	452	496	532	583
	96"	240	292	338	389	434	509	556	600	654
	108"	269	325	380	427	485	572	623	676	725
<b>- Opaque Lining</b>										
Shade Height Up To:	48"	174	203	238	272	305	354	387	425	452
	60"	203	254	289	325	367	432	463	514	547
	72"	238	289	336	383	434	503	547	600	649
	84"	274	327	383	438	498	580	634	685	747
	96"	309	369	434	500	554	652	709	772	840
	108"	349	418	489	547	623	734	798	867	934
<b>Other Optional Surcharges</b>		<b>48"</b>	<b>60"</b>	<b>72"</b>	<b>84"</b>	<b>96"</b>	<b>108"</b>	<b>120"</b>		
Majesty or Noble Wood Valance		120	152	174	198	227	258	287		
1 1/4" or 3" Fabric Banding (per opening)		209								

# Pricing - Manh Truc Panel Drape

PD1 Panel Drape		Shade Width Up To:							
		36"	48"	60"	72"	84"	96"	108"	120"
Shade Height Up To:	48"	289	369	443	483	563	643	723	763
	60"	332	423	507	552	645	736	827	874
	72"	398	507	607	663	772	883	992	1047
	84"	423	538	645	703	818	936	1052	1112
	96"	483	616	736	803	936	1069	1203	1269
	108"	543	692	827	903	1052	1203	1354	1427
	118"	592	756	905	985	1149	1314	1478	1560
<b>Surcharges</b>		<b>36"</b>	<b>48"</b>	<b>60"</b>	<b>72"</b>	<b>84"</b>	<b>96"</b>	<b>108"</b>	<b>120"</b>
Straight/Railroaded Cornice - Unlined		123	140	165	198	234	272	312	343
Straight/Railroaded Cornice - Lined - Light Filtering		225	254	289	336	383	425	467	505
Straight/Railroaded Cornice - Lined - Opaque		265	294	336	385	438	480	527	N/A
Hobbled Cornice - Unlined		147	172	194	238	280	327	374	N/A
Hobbled Cornice - Lined - Light Filtering		249	285	316	374	429	480	532	N/A
Hobbled Cornice - Lined - Opaque		289	323	363	425	485	536	589	N/A
Lining - Light Filtering		165	192	212	232	238	243	254	272
Lining - Opaque		218	265	294	318	327	336	352	369

PD2 Panel Drape		Shade Width Up To:							
		36"	48"	60"	72"	84"	96"	108"	120"
Shade Height Up To:	48"	309	394	472	514	600	685	772	814
	60"	354	452	540	589	687	785	883	932
	72"	425	543	647	707	825	943	1058	1118
	84"	449	574	687	749	874	998	1123	1185
	96"	514	656	785	856	998	1140	1283	1354
	108"	578	738	883	963	1123	1283	1443	1525
	118"	632	807	965	1052	1227	1403	1578	1665
<b>Surcharges</b>		<b>36"</b>	<b>48"</b>	<b>60"</b>	<b>72"</b>	<b>84"</b>	<b>96"</b>	<b>108"</b>	<b>120"</b>
Straight/Railroaded Cornice - Unlined		129	149	174	212	249	289	334	365
Straight/Railroaded Cornice - Lined - Light Filtering		232	260	298	349	396	440	489	529
Straight/Railroaded Cornice - Lined - Opaque		374	412	467	536	598	647	705	529
Hobbled Cornice - Unlined		154	183	207	256	298	343	398	N/A
Hobbled Cornice - Lined - Light Filtering		256	296	332	394	445	494	554	N/A
Hobbled Cornice - Lined - Opaque		398	447	500	580	647	700	769	N/A
Lining - Light Filtering		165	192	212	232	238	243	254	272
Lining - Opaque		218	265	294	318	327	336	352	369

For Additional Surcharges and Options - See page 32

## Pricing - Manh Truc Panel Drape

PD3 Panel Drape		Shade Width Up To:							
		36"	48"	60"	72"	84"	96"	108"	120"
Shade Height Up To:	48"	340	436	520	567	663	756	849	898
	60"	392	498	596	649	758	865	974	1027
	72"	469	598	714	780	909	1038	1169	1234
	84"	496	634	758	827	965	1103	1238	1307
	96"	567	725	865	945	1103	1258	1416	1494
	108"	638	816	974	1063	1238	1416	1594	1680
	118"	696	889	1065	1160	1354	1547	1740	1836
<b>Surcharges</b>		<b>36"</b>	<b>48"</b>	<b>60"</b>	<b>72"</b>	<b>84"</b>	<b>96"</b>	<b>108"</b>	<b>120"</b>
Straight/Railroaded Cornice - Unlined		134	165	183	218	263	303	349	387
Straight/Railroaded Cornice - Lined - Light Filtering		238	276	307	356	409	454	505	549
Straight/Railroaded Cornice - Lined - Opaque		276	316	354	405	465	509	565	387
Hobbled Cornice - Unlined		160	194	216	265	314	360	418	N/A
Hobbled Cornice - Lined - Light Filtering		263	305	340	403	460	512	576	N/A
Hobbled Cornice - Lined - Opaque		303	345	387	452	518	569	634	N/A
Lining - Light Filtering		165	192	212	232	238	243	254	272
Lining - Opaque		218	265	294	318	327	336	352	369

PD4 Panel Drape		Shade Width Up To:							
		36"	48"	60"	72"	84"	96"	108"	120"
Shade Height Up To:	48"	392	500	598	654	763	872	978	1034
	60"	449	574	687	749	874	998	1123	1185
	72"	538	689	823	898	1047	1196	1345	1420
	84"	572	729	874	952	1109	1269	1427	1507
	96"	654	834	998	1087	1269	1449	1632	1720
	108"	734	938	1123	1223	1427	1632	1834	1936
	118"	803	1025	1225	1336	1558	1783	2005	2116
<b>Surcharges</b>		<b>36"</b>	<b>48"</b>	<b>60"</b>	<b>72"</b>	<b>84"</b>	<b>96"</b>	<b>108"</b>	<b>120"</b>
Straight/Railroaded Cornice - Unlined		138	169	187	232	267	316	358	398
Straight/Railroaded Cornice - Lined - Light Filtering		243	280	312	369	414	467	514	560
Straight/Railroaded Cornice - Lined - Opaque		280	320	358	418	472	525	574	398
Hobbled Cornice - Unlined		169	203	223	276	318	383	429	N/A
Hobbled Cornice - Lined - Light Filtering		272	314	347	414	465	534	585	N/A
Hobbled Cornice - Lined - Opaque		312	354	394	463	523	589	643	N/A
Lining - Light Filtering		165	192	212	232	238	243	254	272
Lining - Opaque		218	265	294	318	327	336	352	369

[For Additional Surcharges and Options - See page 32](#)



## Pricing - Manh Truc Panel Drape

PD5 Panel Drape		Shade Width Up To:							
		36"	48"	60"	72"	84"	96"	108"	120"
Shade Height Up To:	48"	387	469	587	672	783	894	1005	1060
	60"	483	587	734	838	978	1116	1256	1327
	72"	578	705	880	1005	1174	1340	1507	1592
	84"	643	783	978	1116	1303	1489	1674	1767
	96"	734	894	1116	1276	1489	1700	1914	2020
	108"	827	1005	1256	1436	1674	1914	2154	2272
	118"	903	1098	1372	1569	1829	2092	2352	2483
<b>Surcharges</b>		<b>36"</b>	<b>48"</b>	<b>60"</b>	<b>72"</b>	<b>84"</b>	<b>96"</b>	<b>108"</b>	<b>120"</b>
Straight/Railroaded Cornice - Unlined		147	176	198	247	289	336	387	427
Straight/Railroaded Cornice - Lined - Light Filtering		249	289	320	385	436	487	543	589
Straight/Railroaded Cornice - Lined - Opaque		289	327	367	434	492	543	600	427
Hobbled Cornice - Unlined		176	209	238	294	343	400	463	N/A
Hobbled Cornice - Lined - Light Filtering		278	320	360	432	489	552	620	N/A
Hobbled Cornice - Lined - Opaque		318	360	407	480	545	607	678	N/A
Lining - Light Filtering		165	192	212	232	238	243	254	272
Lining - Opaque		218	265	294	318	327	336	352	369

Other Optional Surcharges	36"	42"	48"	60"	72"	84"	96"	108"	120"
Majesty or Noble Wood Valance	103	112	120	152	174	198	227	258	287
	<b>36"</b>	<b>48"</b>	<b>60"</b>	<b>72"</b>	<b>84"</b>	<b>96"</b>	<b>108"</b>	<b>120"</b>	
3" Fabric Bottom Banding	43	56	69	80	92	109	120	134	
2" Smooth Wood Pole (Finished) with Ball Finials	292	320	320	360	360	434	434	434	
2" Smooth Wood Pole (Finished) with End Caps	254	287	287	320	320	394	394	394	
Split Draw	87								

# Pricing - Manh Truc Stationary Grommet Panel

G1 Grommet Panel		Shade Width Up To:		
		36"	48"	62"
Shade Height Up To:	48"	483	525	620
	60"	552	603	712
	72"	603	656	776
	84"	667	727	858
	94"	707	772	909
<b>Surcharges</b>		<b>36"</b>	<b>48"</b>	<b>62"</b>
Lining - Light Filtering		165	192	212
Lining - Opaque		218	265	294
3" Fabric Bottom Banding*		43	56	69

G2 Grommet Panel		Shade Width Up To:		
		36"	48"	62"
Shade Height Up To:	48"	543	625	698
	60"	594	683	763
	72"	643	740	829
	84"	712	818	916
	94"	752	865	967
<b>Surcharges</b>		<b>36"</b>	<b>48"</b>	<b>62"</b>
Lining - Light Filtering		165	192	212
Lining - Opaque		218	265	294
3" Fabric Bottom Banding*		43	56	69

G3 Grommet Panel		Shade Width Up To:		
		36"	48"	62"
Shade Height Up To:	48"	580	667	745
	60"	634	729	816
	72"	687	792	885
	84"	760	876	978
	94"	803	925	1034
<b>Surcharges</b>		<b>36"</b>	<b>48"</b>	<b>62"</b>
Lining - Light Filtering		165	192	212
Lining - Opaque		218	265	294
3" Fabric Bottom Banding*		43	56	69

G4 Grommet Panel		Shade Width Up To:		
		36"	48"	62"
Shade Height Up To:	48"	596	685	769
	60"	654	760	856
	72"	714	827	943
	84"	772	903	1027
	94"	829	972	1114
<b>Surcharges</b>		<b>36"</b>	<b>48"</b>	<b>62"</b>
Lining - Light Filtering		165	192	212
Lining - Opaque		218	265	294
3" Fabric Bottom Banding*		43	56	69

G5 Grommet Panel		Shade Width Up To:		
		36"	48"	62"
Shade Height Up To:	48"	625	720	805
	60"	685	787	880
	72"	743	856	956
	84"	820	945	1056
	94"	867	998	1116
<b>Surcharges</b>		<b>36"</b>	<b>48"</b>	<b>62"</b>
Lining - Light Filtering		165	192	212
Lining - Opaque		218	265	294
3" Fabric Bottom Banding*		43	56	69

\* Refer to page 3 for Bottom Banding availability  
**Note: All pricing is PER PANEL.**

# Product Information - Flat & Hobbled Roman Shades - Cordlock

## Flat & Hobbled Roman Product Features

- Fits rectangular window openings
- [Fabric availability: Page 3](#)
- Headrail 2" deep x 1" high, painted or stained to color coordinate
- Flat - folds spaced approximately 7" apart. Hobbled - folds spaced approximately 5" apart.
- TLC Cord sleeve for child safety
- Controls on right side standard
- Color-coordinated wooden tassels and cords.
- Bottom of shade is self-hemmed
- Available with [Traditional](#) or [Contemporary Style](#)

## Important Child Safety Note

In order to comply with the ANSI approved Standard For Safety of Window of Window Covering Products all supplied cord tension/locking devices or cord cleats must be properly installed.

## Size Standards

- [Flat Roman - Page 4](#)
- [Hobbled Roman - Page 4](#)
- [Motorization - Pages 40-44](#)

## Standard Cord Drops (Cordlock)

- Cord length is 40% of the shade length.

## Hardware Included

- [Installation Brackets - Page 51](#)
- 3" Screws for IS Mounts

## Finished Dimensions & Mounting Requirements

- [Page 13](#)

## Options

- [Options and Availability - Page 12](#)
- [Design Option Details - Page 48-50](#)
- [Motorization - Pages 41, 44](#)
- [Exclusions - Page 12](#)

## Approximate Stacking Height

- [Page 14](#)

## Ordering Notes

- A traditional style shade is strongly recommended for inside (jamb to jamb) installations
- Hobbled folds will vary based upon the material selected. Lighter materials tend to produce flatter folds while heavier material tend to billow. Edge Banding enhances the fold.

## Caution

- Manh Truc materials are made from natural materials and will have visible imperfections. Some natural patterns offer slight differences in grain and texture, especially in materials containing knots or slight surface cracks. The finest native materials in shades contain some variations in color and hue. In addition, natural materials can have a slight bow or camber so that horizontal lines or bottom hems might not be perfectly straight. Fold alignment can vary slightly, even on shades that are the same height. Shades made of natural materials tend to stretch slightly over time.

## Pricing

- [Pages: 17-23](#)



Traditional Flat Roman



Traditional Hobbled Roman

## Turned Headrail

- Projection is 1". Only available with Cordlock system. The 2" board is turned on its edge and hardware is installed. The turned headrail allows shades to be installed in shallow window openings and provides a low profile installation on doors.



4" deep x 2" high

# Product Information - Flat & Hobbled Roman Shades - Clutch System

## Flat & Hobbled Roman Product Features

- Fits rectangular window openings
- [Fabric availability: Page 3](#)
- Quick Lift or Traditional system available
- Quick Lift - 2 1/2" deep, Traditional - 2" deep
- Flat - Folds spaced approximately 7" apart
- Hobbled - Folds spaced approximately 5" apart
- TLC Cord sleeve for child safety
- Controls on right side standard
- Bottom of shade is self-hemmed
- Headrail is painted or stained to color coordinate
- Available with [Traditional](#) or [Contemporary Style](#)

## Important Child Safety Note

In order to comply with the ANSI approved Standard For Safety of Window of Window Covering Products all supplied cord tension/locking devices or cord cleats must be properly installed.

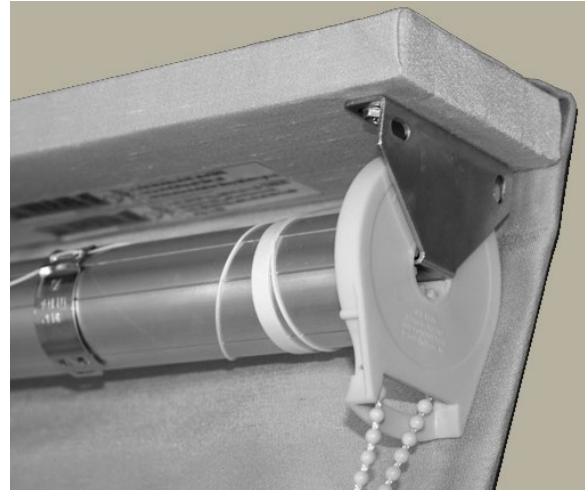

Quick Lift Clutch System

## Size Standards

- [Flat Roman - Page 4](#)
- [Hobbled Roman - Page 4](#)
- [Motorization - Pages 40-44](#)

## Hardware Included

- [Installation Brackets - Page 51](#)
- 3" screws for IS mount
- [Cord Tension Lock - Page 51](#)

## Finished Dimensions & Mounting Requirements

- [Page 13](#)

## Options

- [Options and Availability - Page 12](#)
- [Design Option Details - Page 48-50](#)
- [Motorization - Pages 40-44](#)
- [Exclusions - Page 12](#)



Traditional Clutch System

## Continuous Bead Chain Drops

Shade Length	Drop	Shade Length	Drop
30" - 42"	24"	78 1/16" - 90"	72"
42 1/16" - 54"	36"	90 1/16" - 102"	84"
54 1/16" - 66"	48"	Over 102"	"96
66 1/16" - 78"	60"		

• For inside mount - Chain length must be at least 6" shorter than ordered length to ensure proper tensioner installation.

## Caution

- Manh Truc materials are made from natural materials and will have visible imperfections. Some natural patterns offer slight differences in grain and texture, especially in materials containing knots or slight surface cracks. The finest native materials in shades contain some variations in color and hue. In addition, natural materials can have a slight bow or camber so that horizontal lines or bottom hems might not be perfectly straight. Fold alignment can vary slightly, even on shades that are the same height. Shades made of natural materials tend to stretch slightly over time.

## Pricing

- [Pages: 17-23](#)

## Ordering Notes

- A traditional style shade is strongly recommended for inside (jamb to jamb) installations
- Hobbled folds will vary based upon the material selected. Lighter materials tend to produce flatter folds while heavier material tend to billow. Edge Banding enhances the fold.
- For multiple shades on one headrail, specify control location for each shade and add clutch surcharge per shade.

# Product Information - Flat & Hobbled Roman Shades - CareRING Cordless

## Flat & Hobbled Roman Product Features

- Fits rectangular window openings
- [Fabric availability: Page 3](#)
- Headrail 2 1/2" deep x 1" high
- Rings on back of shade provide folds
- Flat - Folds spaced approximately 7" apart
- Hobbled - Folds spaced approximately 5" apart
- TLC Cord sleeve for child safety
- Controls in the center, on the back side of shade
- Color-coordinated cords.
- Bottom of shade is self-hemmed
- Headrail is painted or stained to color coordinate
- Available with [Traditional](#) or [Contemporary Style](#)

## Size Standards

- [Flat Roman - Page 4](#)
- [Hobbled Roman - Page 4](#)

## Hardware Included

- [Installation Brackets - Page 51](#)
- 3" screws for IS mount

## Finished Dimensions & Mounting Requirements

- [Page 13](#)

## Options

- [Options and Availability - Page 12](#)
- [Design Option Details - Page 48-50](#)
- [Exclusions - Page 12](#)

## Caution

- The springs in the CareRING Cordless system allow for the shade to raise and lower with minimal effort. Excessive force when lowering the shade can cause it to malfunction.
- Manh Truc materials are made from natural materials and will have visible imperfections. Some natural patterns offer slight differences in grain and texture, especially in materials containing knots or slight surface cracks. The finest native materials in shades contain some variations in color and hue. In addition, natural materials can have a slight bow or camber so that horizontal lines or bottom hems might not be perfectly straight. Fold alignment can vary slightly, even on shades that are the same height. Shades made of natural materials tend to stretch slightly over time.

## Pricing

- [Pages 17-23](#)
- To price add the CareRING Cordless surcharge to base shade price.



Traditional Flat Roman



Contemporary Hobbled Roman



CareRING Cordless (shade back)

# Product Information - Duo-Shade

## Duo-Shade Product Features

- Separate flat roman shade and liner shade mounted on one headrail with independent controls
- Fits rectangular window openings
- Available with all Manh Truc fabrics
- Rings on back of shade and clear rods on back of liner provide folds
- TLC Cord sleeve for child safety
- Controls for shade on right, controls for liner on left
- Color-coordinated cords. Lift cord will be 40% of the shade length
- Bottom of shade is self-hemmed
- Headrail is painted or stained to color coordinate
- Available with [Traditional](#) or [Contemporary Style](#)

## Important Child Safety Note

In order to comply with the ANSI approved Standard For Safety of Window of Window Covering Products all supplied cord tension/locking devices or cord cleats must be properly installed.

## Size Standards

- [Duo-Shade - Page 9](#)

## Hardware Included

- [Installation Brackets - Page 51](#)
- 3" screws for IS mount

## Finished Dimensions & Mounting Requirements

- [Page 13](#)

## Options

- [Options and Availability - Page 12](#)
- [Design Option Details - Page 48-50](#)
- [Motorization - Pages 40-44](#)
- [Exclusions - Page 12](#)

## Caution

- Manh Truc materials are made from natural materials and will have visible imperfections. Some natural patterns offer slight differences in grain and texture, especially in materials containing knots or slight surface cracks. The finest native materials in shades contain some variations in color and hue. In addition, natural materials can have a slight bow or camber so that horizontal lines or bottom hems might not be perfectly straight. Fold alignment can vary slightly, even on shades that are the same height. Shades made of natural materials tend to stretch slightly over time.

## Pricing

- [Pages 17-23](#)
- The Duo-Shade Liner surcharge is based upon which lining is selected, that price is added to the base shade price.



# Product Information - Specialties

## Roman Arch

- [Fabric availability: Page 9](#)
- Flat Roman Arch is stationary and will NOT raise.
- Pattern runs horizontally as shown in the diagram.
- Arch height cannot exceed 1/2 of the arch width.
- Standard Arch - Board depth is 7/8"; Board height is 2".
- Material is secured to a wooden frame with staples, staples are hidden using gimp around the arch top.
- Button catches are sent for installation.
- Framed Arch - Frame depth is 1"; Frame height is 1 5/8".
- Routed Framed Arch - Frame depth is 1"; Frame height is 2".
- Framed or Routed Framed Arch are available in 14 colors: Accessible Beige, Buckeye, Cottage Pine, Ebony Wash, Gardenia, Harmony, Java Roast, Mahogany, Moonshine, Natural, Navajo White, Revere Pewter, Snow White, Thunder.
- **Template Required**

## Roman Angle

- [Fabric availability: Page 9](#)
- Roman Right Angle Triangle or Isoceles Triangle is stationary.
- Pattern runs horizontally.
- Triangle height cannot exceed 1/2 of the triangle width.
- Standard Triangle - Board depth is 7/8"; Board height is 2".
- Framed Triangle - Frame depth is 1"; Frame height is 1 5/8".
- Routed Framed Triangle - Frame depth is 1"; Frame height is 2".
- Material is secured to the front of a wooden frame with staples, staples are hidden using gimp.
- Button catches are sent for installation
- Framed or Routed Framed Arch are available in 14 colors: Accessible Beige, Buckeye, Cottage Pine, Ebony Wash, Gardenia, Harmony, Java Roast, Mahogany, Moonshine, Natural, Navajo White, Revere Pewter, Snow White, Thunder.
- **Template Required**

## Size Standards

- [Page 9](#)

## Size Standards

- [Page 9](#)

## Pricing

- [Pages 17-23](#)
- Price shade using highest point of arch to bottom height, then add the Arch surcharge. Framed and Routed Framed Arch are also available for a surcharge.

## Pricing

- [Pages 17-23](#)
- Price shade using highest point of angle to bottom height, then add the Arch/Angle surcharge. Framed and Routed Framed Triangles are also available for a surcharge.



Arch with frame

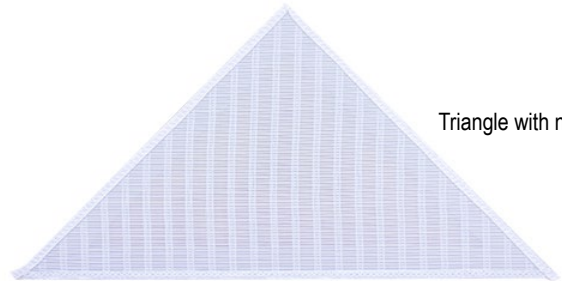

Triangle with no frame



Arch with no frame



Right Angle Triangle with frame



Triangle with frame

# Product Information - Specialties

## Angle Top Flat Roman Shade

- Fits window openings with a sloped top board; specify short point height and side (left or right) and long point height. A diagram is required.
- Shade operates as standard rectangular cord lock, shade raises only to the bottom of the angle.
- [Fabric availability: Page 9](#)
- Maximum angle of slope is 35°
- Self-valance and cord lift system with cord to the front of shade
- Material is secured to a 1" or 2" projection board with staples; staples are hidden using gimp.
- Shade valance is 7" long at the shortest point of slope; Cord lock is on the short side of the angle.
- If a lined angle top flat roman shade is ordered, lining extends into the angle.
- L-brackets for easy installation
- Cords will be 40% of the shade length.
- **Template Required**

## Size Standards

- [Page 9](#)

## Options

- [Options and Availability - Page 12](#)
- [Design Option Details - Pages 48-50](#)
- [Exclusions - Page 12, Angle bottom, Returns](#)

## Pricing

- [Pages 17-23](#)
- Price shade using long side as height, then add the Angle Top surcharge.

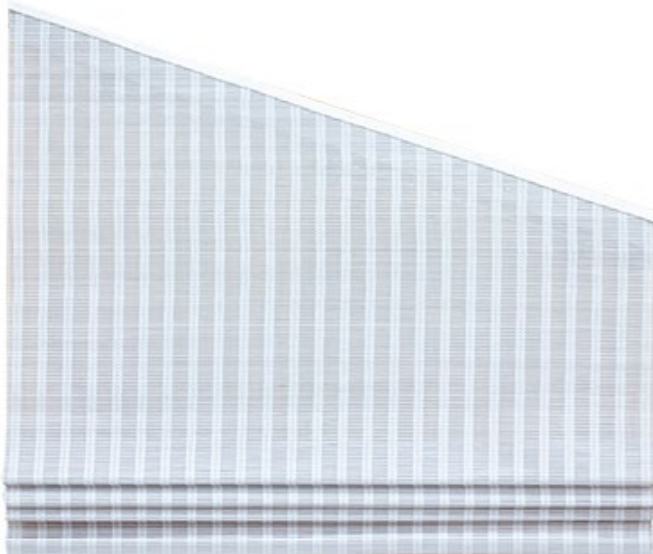

## Arch Top Flat Roman Shade

- Fits window openings with an arched top opening.
- Shade operates as standard rectangular, shade raises only to the bottom of the arch top.
- [Fabric availability: Page 9](#)
- Arch height cannot exceed 1/2 of the arch width.
- 2" deep x 1" high headrail
- Material is secured to a 3/4" projection wooden frame with staples, staples are hidden using gimp around the arch top edge.
- Choose self-valance or no valance; Flat valance length is approx. 7" longer than the bottom of the arch portion; cord controls can be on either side of shade.
- If a lined arch top flat roman shade is ordered, lining extends into the arch.
- L-brackets for easy installation
- Cords will be 40% of the shade length.
- **Template Required**

## Size Standards

- [Page 9](#)

## Options

- [Options and Availability - Page 12](#)
- [Design Option Details - Page 48-50](#)
- Edge Banding is available only in banding configuration VBH2.
- [Exclusions - Page 12](#)

## Pricing

- [Pages 17-23](#)
- Price shade using highest point of arch to bottom height, then add the Arch Top surcharge.





# Product Information - Somfy Battery Operated Series



## Size Standards

Battery and Rechargeable Motorization	Flat - Unlined				
	Minimum Width	Maximum Width	Minimum Height	Maximum Height	Maximum Sq.Ft.
System II	17"	96"	30"	96"	50
R28 WireFree	26"	96"	30"	96"	50
Sonesse 30 WireFree	27"	96"	30"	96"	64
Ultra 30 WireFree	31"	96"	30"	96"	64
Flat - Light Filtering					
System II	17"	96"	30"	96"	45
R28 WireFree	26"	96"	30"	96"	45
Sonesse 30 WireFree	27"	96"	30"	96"	64
Ultra 30 WireFree	31"	96"	30"	96"	64
Flat - Opaque					
System II	17"	96"	30"	96"	40
R28 WireFree	26"	96"	30"	96"	40
Sonesse 30 WireFree	27"	96"	30"	96"	64
Ultra 30 WireFree	31"	96"	30"	96"	64

For Fabric Width and Sq Ft. Restrictions - See page 3

\* Pattern Caracas not available motorized. For Hobbled shades, maximum is 84" x 84" for all motors.

### System II Information (1.1Nm)

- 12V DC Motor
- Can be powered via 8AA Lithium batteries, Solar Pack Kit, Transformer, hardwired, or rechargeable battery pack
- Adjustable speed 10 - 28 RPM
- Compatible with all of Somfy's RTS transmitters
- Uses a 2 1/2" headrail



System II Motor

### R28 WireFree Information

- Built in lithium-ion rechargeable battery (2600 mAh)
- Uses a 2 1/2" headrail
- Adjustable speed 10 - 28 RPM
- Compatible with all of Somfy's RTS transmitters
- 55 decibels
- Will ship at a 30% charge; Needs 4-6 hrs for full peak charge
- Soft Start/Soft Stop



R28 Wirefree Motor

### Sonesse 30 Wirefree Information (2Nm)

- Built in Lithium-ion rechargeable battery (2600 mAh)
- Uses a 2 1/2" headrail
- Adjustable speed 10-28 RPM
- Compatible with all of Somfy's RTS transmitters
- 44 decibels
- Will ship at a 30% charge; Needs 4-6 hrs for full peak charge
- Soft Start/Soft Stop



Sonesse 30 Wirefree Motor

### Ultra 30 Wirefree Information (2Nm)

- Built in Lithium-ion rechargeable battery (2600 mAh)
- Uses a 2 1/2" headrail
- Adjustable speed 10-28 RPM
- Compatible with all of Somfy's RTS transmitters
- Ultra quiet sound level (38 decibels)
- Will ship at a 30% charge; Needs 4-6 hrs for full peak charge
- Soft Start/Soft Stop



Ultra 30 Wirefree Motor

## Finished Dimensions & Mounting Requirements

- [Pages 13](#)

## Pricing

- [Pages: 17-23](#)
- To price, add motorization surcharges ([page 25](#)) to shade price

## Ordering Notes

- Order Transmitter(s) or Wall Switch(s) as required.
- Check for other options required that are available.
- Choose left or right side for power cord and motor.
- Window length is required so that the limits can be set

# Product Information - Somfy Battery Operated Series



## Somfy myLink Overview

- WiFi to RTS bridge that can control up to 16 channels of RTS motorized products using the Somfy myLink apps for iOS and Android devices.
- Using the app, users can send immediate RTS commands, create Scenes and Schedules.
- Users can access their myLinks from anywhere with the apps' remote access feature.
- Multiple myLinks can be joined within the same system for multi-zone control.
- Can also serve as an IP to RTS bridge for 3rd party control systems.
- Amazon Alexa integration
- IFTTT (If This Then That)



## Options - Controls



Sixteen Channel Telis RF Transmitter



Five Channel Telis RF Transmitter



Single Channel Telis RF Transmitter



Five Channel Decoflex Wall Switch



Situ 1 Channel Remote



Situ 5 Channel Remote

Design Options Availability	System II	R28 WireFree	Sonnesse 30 WireFree	Ultra 30 WireFree
<b>No Charge Design Options</b>				
Contemporary Style	Y	Y	Y	Y
Traditional Style	Y	Y	Y	Y
Hold Down Brackets	Y	Y	Y	Y
New York Brackets	N/A	N/A	N/A	N/A
Turned Headrail	N/A	N/A	N/A	N/A
<b>Surcharge Design Options</b>				
FR or Antimicrobial	Y	Y	Y	Y
Edge Banding	Y	Y	Y	Y
Lining	Y	Y	Y	Y
2-on-1 / 3-on-1 Headrail*	Y	Y	Y	Y
Straight Trim	Y	Y	Y	Y
Additional Valance Length	Y	Y	Y	Y
Wood Bottom Hem	Y	Y	Y	Y
Majesty Wood Valance	Y	Y	Y	Y
Noble Wood Valance	Y	Y	Y	Y
Light Gap Stop	Y	Y	Y	Y

\* Requires multiple motors

## Motorization Services

- Customer Service Motorization Skill Set > 800-342-5523 > motor@lafvb.com
- Technical Support by trained Customer Service Agents
- Assistance in the specification of motorization applications
- Liason between dealers/designers, electricians and home automation integrators.

# Product Information - Auto-Wand Motorization Version 2.0



## Auto-Wand Product Features

- Uses a 2 1/2" headrail
- Battery operated motor with wand control.
- Economical child safe solution with no cords.
- Up or Down position controlled by button on wand.
- Top and bottom limits can be set.
- Li-ion battery is internal and rechargeable. (2200 mAh)
- Wand is White, Gray or Black.
- Wand control is on either side of the shade.
- Rechargeable battery can offer 6 to 12 months on a single charge under normal conditions.
- 5 Year Motor Warranty
- Will ship at a 30% charge
- Traditional style only



## Size Standards

Battery and Rechargeable Motorization	Flat - Unlined				
	Minimum Width	Maximum Width	Minimum Height	Maximum Height	Maximum Sq.Ft.
Auto-Wand	24"	96"	30"	96"	50
Flat - Light Filtering					
Auto-Wand	24"	96"	30"	96"	45
Flat - Opaque					
Auto-Wand	24"	96"	30"	96"	40
<a href="#">For Fabric Width and Sq Ft. Restrictions - See page 3</a>					

\* Pattern Caracas not available motorized

## Wand Length

Shade Length	Wand
Up to 39"	24"
39 1/16" - 54"	36"
Over 54 1/16"	48"



Wand Control

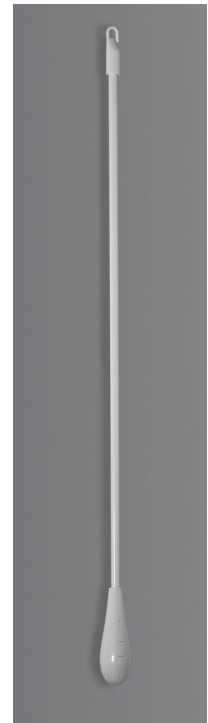

## Options

- [Design Options Headrail Availability - Page 12](#)
- [Design Options Availability - Page 44](#)
- [Design Option Details - Page 48-50](#)
- [Exclusions: Page 12](#)

## Hardware Included

- [Installation Brackets - Page 51](#)

## Finished Dimensions & Mounting Requirements

- [Page 13](#)

## Pricing

- [Pages: 17-23](#)
- To price, add motorization surcharges ([page 26](#)) to shade price

# Product Information - EZ Charge™ Lithium Rechargeable Series



## EZ-Charge Product Features

- Uses a 2 1/2" headrail
- Battery powered motor with remote control, wall switch or app interface (all purchased separately).
- Lithium-ion battery is internal and rechargeable.
- Remote offers up to 15 channels separately or in groups.
- Electronic stop setting.
- Rechargeable battery can offer 6 to 12 months on a single charge under normal conditions. Charger has a 12' cord sold separately. Extension cables sold separately.
- 6 hours for a full peak charge (from a complete dead to a full charge).
- Warning sound when battery charge is low.
- Economical child safe solution with no cords.
- 5 Year Motor Warranty
- Will ship at a 30% charge



## Size Standards

Battery and Rechargeable Motorization	Flat - Unlined				
	Minimum Width	Maximum Width	Minimum Height	Maximum Height	Maximum Sq.Ft.
EZ-Charge V.2	24"	96"	30"	96"	50
EZ-Charge X2	32"	96"	30"	96"	64
EZ-Charge X3	42"	118"	30"	96"	80
Flat - Light Filtering					
EZ-Charge V.2	24"	96"	30	96"	45
EZ-Charge X2	32"	96"	30	96"	64
EZ-Charge X3	42"	118"	30	96"	80
Flat - Opaque					
EZ-Charge V.2	24"	96"	30"	96"	40
EZ-Charge X2	32"	96"	30"	96"	64
EZ-Charge X3	42"	118"	30"	96"	80

For Fabric Width and Sq Ft. Restrictions - See page 3

\* Pattern Caracas not available motorized. For Hobbled shades, maximum is 84" x 84" for all motors.

### EZ-Charge Version 2.0 (1.1Nm)(2200 mAh)

- Adjust speed: 40 RPM (30 RPM or 20 RPM)
- 2 1/2" Headrail

### EZ-Charge X3 (Q-3Nm)(4400 mAh)

- Adjust speed: 28 RPM (24 RPM or 20 RPM)
- 3 1/2" Headrail

### EZ-Charge X2 (Q-2Nm)(2600 mAh)

- Adjust speed: 28 RPM (24 RPM or 20 RPM)
- 2 1/2" Headrail

## Options - Version 2.0 and X2 Systems

- [Design Options Headrail Availability - Page 12](#)
- [Design Options Availability - Page 44](#)
- [Design Option Details - Page 48-50](#)
- [Exclusions: Page 12](#)

## Options - X3 System

- [Design Options Headrail Availability - Page 12](#)
- [Design Options Availability - Page 44](#)
- [Design Option Details - Page 48-50](#)
- [Exclusions: Page 12](#)

## Finished Dimensions & Mounting Requirements

- [Page 13](#)

## Pricing

- [Pages: 17-23](#)
- To price, add motorization surcharges ([page 26](#)) to shade price

# Product Information - Auto-Wand & EZ-Charge Rechargeable Series



## EZ Charge Pulse Bridge

- Allows for app control over any of your EZ Charge Series motors
- Set and manage up to 20 scenes
- Set and manage up to 20 timers
- Manage multiple hubs under multiple locations. Easily switch between office and home. Allows for up to 5 hubs under each location
- Allows for third party serial integration
- Amazon Alexa compatible
- IFTTT (If This Then That)



Pulse Bridge

## EZ Charge Repeater

- Extends the RF range of operation up to 120 feet for ARC enabled products
- Operates by plugging the USB power adapter into a power outlet and then plugging the USB Repeater into the USB power adapter
- Press any button on the remote control and the blue light on the USB Repeater will flash three times. This means the USB Repeater is transmitting the signal
- Power adapter not included



## Options - Controls



EZ-Charge  
15 Channel Remote Control



EZ-Charge Charger with 12 foot cord



EZ-Charge Wall Switch

Design Options Availability	Auto-Wand	EZ-Charge V2	EZ-Charge X2	EZ-Charge X3
<b>No Charge Design Options</b>				
Contemporary Style	N/A	Y	Y	Y
Traditional Style	Y	Y	Y	Y
Hold Down Brackets	Y	Y	Y	Y
New York Brackets	N/A	N/A	N/A	N/A
Turned Headrail	N/A	N/A	N/A	N/A
<b>Surcharge Design Options</b>				
FR or Antimicrobial	Y	Y	Y	Y
Edge Banding	Y	Y	Y	Y
Lining	Y	Y	Y	Y
2-on-1 / 3-on-1 Headrail*	Y	Y	Y	Y
Straight Trim	Y	Y	Y	Y
Additional Valance Length	Y	Y	Y	Y
Wood Bottom Hem	Y	Y	Y	Y
Majesty Wood Valance	Y	Y	Y	Y
Noble Wood Valance	Y	Y	Y	Y
Light Gap Stop	Y	Y	Y	Y

\* Requires multiple motors

## Motorization Services

- Customer Service Motorization Skill Set > 800-342-5523 > motor@lafvb.com
- Technical Support by trained Customer Service Agents
- Assistance in the specification of motorization applications
- Liason between dealers/designers, electricians and home automation integrators.

# Product Information - Panel Track

## Product Features

- Fits rectangular window openings
- [Fabric availability: Page 3](#)
- **Edge Banding is required on Panel Track shades.**
- 1 1/4" Twill Banding
- One Way Draw or Split Draw.
- Cord Draw Control.
- Split Draw with cord draw always uses a 5 channel track.
- Front Panel Draw is standard (panels stack in front of each other with fixed panel closest to the window side).
- Brown or White aluminum track system.
- Track can be ceiling or wall mounted
- Track uses sturdy delrin wheeled carriers.
- Material is attached with hook and loop system and reinforced with screws.
- Approximate 3" panel overlap
- Aluminum bar is inserted into bottom hem.

## Size Standards

- [Page 11](#)

## Important Child Safety Note

In order to comply with the ANSI approved Standard For Safety of Window of Window Covering Products all supplied cord tension/locking devices or cord cleats must be properly installed.

## Hardware Included

- [Installation Brackets -Page 51](#)
- Cord Tensioner Bracket with Cord Draw

## Finished Dimensions & Mounting Requirements

- [Page 14](#)

## Options

- [Options and Availability - Page 12](#)
- [Design Option Details - Page 48-50](#)
- [Exclusions - Page 12](#)

## Ordering Notes

- For windows greater than 144", tracks may be butted but panels will not meet.
- Shades less than 7' long have a 36" wand standard; Shades 7' or greater have a 48" wand standard

## Approximate Panel Size

- See table on [page 16](#) for approximate panel size.

## Pricing

- [Pages 27-29](#)

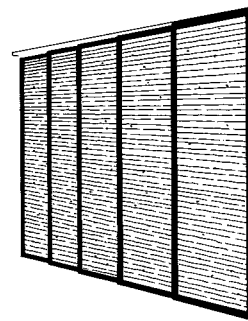

## Caution

- Manh Truc materials are made from natural materials and will have visible imperfections. Some natural patterns offer slight differences in grain and texture, especially in materials containing knots or slight surface cracks. The finest native materials in shades contain some variations in color and hue. In addition, natural materials can have a slight bow or camber so that horizontal lines or bottom hems might not be perfectly straight. Fold alignment can vary slightly, even on shades that are the same height. Shades made of natural materials tend to stretch slightly over time.

# Product Information - Panel Drape

## Product Features

- Fits rectangular window openings
- [Fabric availability: Page 3](#)
- Panel Drape material is RAILROADED (turned sideways)
- One Way Draw. A locking pin provides a stationary end or Split Draw with recessed magnets on wooden rails
- Fabric Banding (1" showing) across the top
- Approximately 1.5x's Fullness
- Panel Drape stacks to approx. 15% of total track width
- Brown, White or Gray Hand Traverse Track.  
Gray and white track have white carriers.  
Brown track has brown carriers.
- Track system is 1/2" high and 5/8" deep extruded aluminum.
- Track can be ceiling mounted or wall mounted.



## Size Standards

- [Page 11](#)

## Hardware Included

- [Installation Brackets - Page 51](#)

## Finished Dimensions & Mounting Requirements

- [Page 14](#)

## Options

- [Options and Availability - Page 12](#)
  - Knobs on wood edge: 3/4" Brass, Antique Brass or Nickel
- [Design Option Details - Page 48-50](#)
- [Exclusions - Page 12](#)



Sahara Channel Track with Sahara Finial

## Ordering Notes

- Sahara Channel Track (H Rail) can be ordered separately.
- For windows wider than 120", the tracks may be butted and the panels will not meet.
- Lining length is 1/2" less than Panel Drape length.
- Deduct 1/2" for floor clearance on ceiling mount installation.



Carrier Attachment

## Caution

- Manh Truc materials are made from natural materials and will have visible imperfections. Some natural patterns offer slight differences in grain and texture, especially in materials containing knots or slight surface cracks. The finest native materials in shades contain some variations in color and hue.

## Pricing

- [Pages 30-32](#)

## Panel Drape with No Track

- Carriers are attached to Panel Drape. Select carrier color: White or Brown.

## Ordering Notes for Sahara Channel Track

- A Sahara Mechanical Channel Track can be ordered separately.
- Panels will come ordered width and height.
- Order Sahara channel track width 1 1/2" greater than Panel Drape ordered width.
- Select Sahara pole color, brackets (WI-16XXX), and finials.
- See the Lafayette Drapery Hardware price list for Sahara Channel Track pricing.

# Product Information - Stationary Grommet Panels

## Product Features

- Fits rectangular window openings
- [Fabric availability: Page 3](#)
- Grommet Panel material is RAILROADED (turned sideways) - see picture below. Panel length cannot exceed fabric width.
- Approximately 2x's Fullness
- 3 1/2" Returns
- 3" Fabric Banding showing on the top of the Grommet Panel.
- 1 1/2" Fabric Banding showing on the panel sides.
- Grommets are 2 1/8" OS diameter and fit up to a 1 3/8" diameter rod or pole.
- Choose from one of six grommet colors: Matte Nickel, Antique Brass, Antique Copper, Black, Satin Smoke, or Oil Rubbed Bronze.

## Size Standards

- [Page 11](#)

## Options

- [Options and Availability - Page 12](#)
- [Design Option Details - Page 48-50](#)
- [Exclusions - Page 12](#)

## Ordering Notes

- Pricing is PER PANEL.
- Rod or pole is purchased separately.
- Refer to Lafayette Drapery Hardware or Kirsch Drapery Hardware price list.
- Lining length is 1/2" less than Panel length.



## Finished Dimensions & Mounting Requirements

- [Page 14](#)

## Caution

- Non-functioning panel - designed to be used as a stationary panel only.
- Manh Truc materials are made from natural materials and will have visible imperfections. Some natural patterns offer slight differences in grain and texture, especially in materials containing knots or slight surface cracks. The finest native materials in shades contain some variations in color and hue. In addition, natural materials can have a slight bow or camber so that horizontal lines or bottom hems might not be perfectly straight. Fold alignment can vary slightly, even on shades that are the same height. Shades made of natural materials tend to stretch slightly over time.

## Pricing

- [Page 33](#)



Inside Diameter: 1 1/2"  
Outside Diameter: 2 1/8"



6 Grommets



8 Grommets



12 Grommets



# Design Options - Valances and Cornices

## Manh Truc Roman Shade Self-Valance

- A 7" long flat self-valance is standard with each Flat Roman and Hobbled Roman woven shade. If shade is lined, the accompanying self-valance is lined.
- See [finished dimensions](#) for standard return based on shade style and inside/outside mount designation.
- Structured returns standard on Traditional style. Wrapped End is standard on Contemporary style. Soft returns are standard on Contemporary style with CareRING
- Self-valances longer than 7" and up to 36" are available
- For 2-on-1 Headrail, when valance width exceeds material width, the valance is split in the center and butted together.
- For 3-on-1 Headrail, when valance width exceeds material width, the valance follows the shade configuration.
- Gimp trim is available on the valance hem for a surcharge.



Structured Return



Wrapped End



Soft Return

## Majesty and Noble Wood Valances

- For Panel Track or Panel Drape
- Valances are available in 14 colors: Accessible Beige, Buckeye, Cottage Pine, Ebony Wash, Gardenia, Harmony, Java Roast, Mahogany, Moonshine, Natural, Navajo White, Revere Pewter, Snow White, Thunder. Sample chips are available using [MySwatch](#).
- Standard return is 6" from back of valance to wall.
- If wood valance width is over 96" the valance will be spliced. Maximum spliced width is 132".

Majesty Valance  
4 1/2" height  
5/8" thick



Noble Valance  
4 5/8" height  
1/2" thick



## Hobbled Cornice

- Two 6" hobbled folds form a 12" long cornice, order separately.
- Hobbled Cornice includes fabric covering the top of board and legs.
- Maximum hobbled cornice width is equal to the [material width](#).
- Available with 2", 3 1/2" or 5 1/2" returns.
- Edge Banding is on cornice face side edges only (VOS2).  
[See page 10 for availability.](#)

## Ordering Notes

- For Panel Track - order a 3 1/2" return for 3 channels or 5 1/2" return for 4 or 5 channels.
- If cornice is going over a shade, order cornice 2" wider than shade width due to side leg boards.



Hobbled Cornice

## Straight or Railroaded Cornice

- A stand-alone 7" long cornice ordered separately.
- Available with 2", 3 1/2" or 5 1/2" returns.
- Straight Cornice has material running in same direction as the woven shade or Panel Track, and perpendicular to Panel Drape.
- Straight Cornice includes fabric covering top of board and legs.
- Maximum Straight Cornice width is 120". If the cornice width is greater than the shade material, the cornice is split into two equal widths.
- Railroaded Cornice has material perpendicular to the woven shade or Panel Track
- Maximum Railroaded Cornice width is 120".

## Ordering Notes

- If cornice is being ordered separately to go over a shade, order cornice 2" wider than shade width to allow for side leg boards.

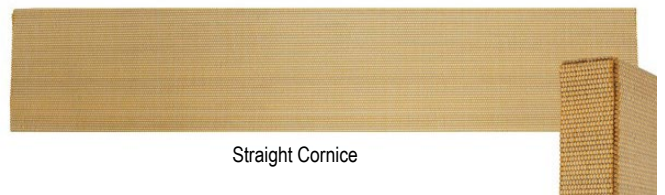

Straight Cornice



Railroaded Cornice

Valance/Cornice Options Availability	Self Valance	Straight Cornice	Railroaded Cornice	Hobbled Cornice	Majesty or Noble Valance
No Charge Option					
Non-standard return sizes	N/A	Y	N/A	Y	Y
Surcharge Options					
Banding*	Y	Y**	Y**	N/A	N/A
Lining	Y	Y	Y**	N/A	N/A
Optional Length	Y	Y	Y**	Y	N/A

\* See [page 10](#) for availability and [page 50](#) for configurations

\*\* Bottom edge only

# Design Options - Other Options

## Panel Drape - Decorative Wood Poles

- Can only be ordered for outside mount Panel Drape.
- 2" Smooth Decorative Wood Pole is finished and routed for track insertion.
- Select one of nine paint or stain finishes from the wood valance collection: Buckeye, Cottage Pine, Ebony Wash Gardenia, Java Roast Mahogany, Natural, Navajo White, Thunder
- Select either the Ball Finial or End Cap to be finished in the same finish selected for the Decorative Wood Pole.
- Standard return from back of pole to wall is 3 1/2".
- Maximum pole width is 120".
- Wood End Brackets and brass support brackets are included for installation.
- Pole is 3" greater than the ordered width.
- Caution: Due to varying wood grains the pole, bracket, and finials will not be an exact match.



Ball Finial

End Cap

Wood Installation Bracket

## Mitered Corners

- Available for flat roman shades.
- A template is required with dimensions A, B, C, D, and E indicated to determine the miter angle.
- Two adjoining shades can be mitered for corner or bay windows.
- Mitered shades cannot be raised to the same height level and will not fully raise due to the folds.
- Not available on hobbled shades, turned headrail or clutch system.
- Lift cords are mounted opposite the miter for corner windows; for bay windows, center shade has cords on right.
- Horizontal pattern alignment is not guaranteed.

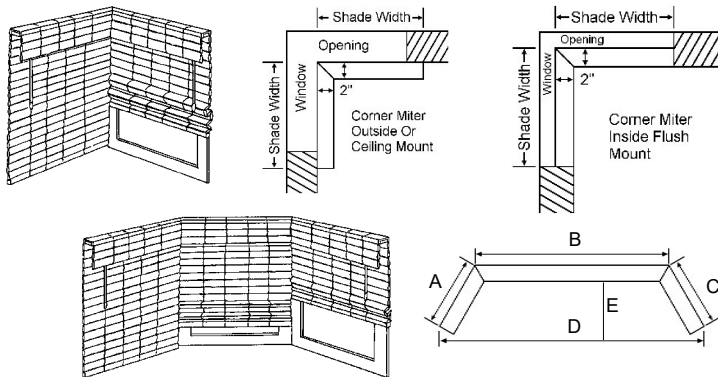

## Top Down/Bottom Up Shade

- Shade forms accordion folds when raised or lowered.
- Shade lowers from the top and raises from the bottom; two sets of cords and cord locks.
- Right cord raises and lowers top of shade; left cord raises and lowers bottom of shade
- Valance and cord lift system with cord to the front of the shade.
- Shade has a 7" long self-valance for both front and back of shade to conceal hardware.
- Cords are visible when shade is lowered from the top.
- Not available with multiple shades on one headrail.
- Lining option available; however shade must have edge banding. [See page 3 for availability](#)
- For outside mount, structured returns standard; wrapped ends can be requested at no charge.
- Size limitations: Minimum width 24"; Maximum width varies by shade material (see page ); Maximum length 108"



## Multiple Shades on One Headrail

- Available on flat and hobbled roman shades in both Traditional or Contemporary style.
- Two or three shades which share the same headrail and operate independently. Shades have a 1/2" gap.
- For 2-on-1 headrail - when valance width exceeds material width, valance is split in the center and butted together.
- For 3-on-1 headrail - when valance width exceeds material width, valance follows shade configuration.
- Cords to outside edge of shade unless otherwise specified; for 3-on-1 headrail, center shade has cords on right.
- Shades are patterned to match valance.
- Horizontal pattern alignment is not guaranteed.
- Size limitations: maximum overall width is 144"



## Traditional or Contemporary Style

- Traditional style: Headrail projection of 2" ( $\pm 1/8$ "); Self-valance and cord lift system to front of shade. Flat self-valance hangs approx. 7" off the headrail with cords behind the valance. IS mount shade has no returns. OS mount shade has [structured returns](#).
- Contemporary style: Headrail projection of 2" ( $\pm 1/8$ "); Material off front - cord to back of shade. IS mount shade has no returns. OS mount shade has [wrapped ends](#).

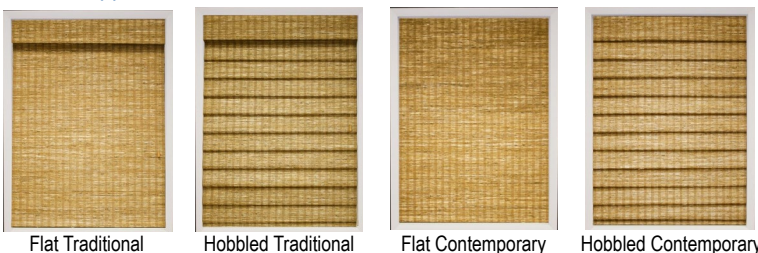

Flat Traditional

Hobbled Traditional

Flat Contemporary

Hobbled Contemporary

Stainless Steel

Antique Bronze

Gun Metal

Burnished Copper

## Bead Chain Options

- Available on clutch operated roman shades.
- Color coordinated to the shade color. Chain lengths must be 6" shorter than window length for ISM to properly install tensioner
- Metal Bead Chain in Stainless Steel, Antique Bronze, Gun Metal or Burnished Copper are available for a surcharge.

# Design Options - Other Options

## Flat or Hobbled Roman Shade Edge Banding

- Edge Banding is wrapped around the edges of the shade or valance and sewn in place. [See page 3 for availability](#)
- Four edge banding styles are available:
  - 1 1/4" width twill banding in 13 solid colors  
(5/8" of banding shows on front and back of shade)
  - 3" width twill banding in 13 solid colors  
(1 1/2" of banding shows on front and back of shade)
  - 1 1/4" width fabric banding in 12 solid colors  
(5/8" of banding shows on front and back of shade)
  - 3" width fabric banding in 12 solid colors  
(1 1/2" of banding shows on front and back of shade)
- Can be combined with lining.
- Vertical banding will overlap horizontal banding at the corners.
- Bottom hem banding is 3" to cover the weight bar inserted in hem.
- For multiple shades on one headrail, add banding surcharge for each shade.
- For multiple shades on one headrail, banding on valance will not align vertically with banding on the adjacent shade due to the 1/2" gap between shades.
- Select banding color from the Twill Banding Sample Card and Fabric Banding Sample Card in the sample book.
- Six banding configurations are available:

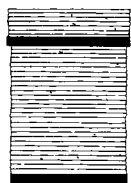

Self-Valance Hem/Bottom Hem - VBH2



Self-Valance Sides/Shade Sides - VSS2

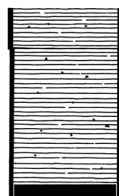

Sides/Bottom Hem - SBH3



Both Sides and Hems - BSH4

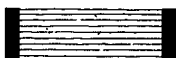

Valance/Cornice Only Sides - VOS2



Valance/Cornice Only Sides and Hem - VOB3  
(Not available in a Hobbled Cornice)

Notes:  
Edge Banding will show on the bottom hem even when the shade is in the raised position.

On a Hobbled Shade, the fold is enhanced with edge banding and will form a billow.



## Panel Drape Banding

- 1 1/2" Fabric Banding showing on top edge of Panel Drape is standard. Can be added to bottom edge as option. [See page 3 for fabric availability.](#)

## Grommet Panel Banding

- 3" fabric banding showing on top and 1 1/2" on vertical edge of Grommet Panel is standard. Can be added to bottom edge as option. [See page 3 for fabric availability.](#)

## Panel Track Edge Banding

- Edge banding is wrapped around the edges of each panel and sewn in place.
- The 1 1/4" twill edge banding with a 3" twill on bottom hem is included in the Panel Track price.
- All Panel Track bottom hems are made with 3" banding to cover weight bar.
- 3" Twill edge banding is available at no charge. 1 1/4" or 3" Fabric Banding are available for a surcharge.
- Edge banding styles available:
  - 1 1/4" width twill banding in 13 solid colors  
(5/8" of banding shows on front and back of shade)
  - 3" width twill banding in 13 solid colors  
(1 1/2" of banding shows on front and back of shade)
  - 1 1/4" width fabric banding in 12 solid colors  
(5/8" of banding shows on front and back of shade)
  - 3" width fabric banding in 12 solid colors  
(1 1/2" of banding shows on front and back of shade)
- Vertical banding will overlap horizontal banding at corners.
- Select banding color from the Twill Banding Sample Card or Fabric Banding Sample Card in the sample book.

## Manh Truc Wood Bottom Hem

- Available for flat roman and hobbled roman shades. [See page 3 for availability](#)
- Wood bottom hem is 2" high x 5/8" deep.
- Maximum shade width using a wood bottom hem is 72".
- Wood Bottom Hem is available in nine colors: Buckeye, Cottage Pine, Ebony Wash, Gardenia, Java Roast, Mahogany, Natural, Navajo White, Thunder
- For multiple shades on one headrail, add hem surcharge for each shade. (Ex: For 3 on 1 headrail, add 3 wood bottom hem surcharges.)



## Manh Truc Straight Trim

- Available for flat roman shades and hobbled roman shades
- Trim is applied to the straight bottom edge of either valance hem or shade hem.
- Indicate trim style/color item number and placement. The surcharge for trim is per row. If straight trim is desired on BOTH valance and shade bottom, multiply the surcharge by 2.
- Woven shade trim surcharge includes gimp available from Embellishments collection up to a RETAIL price of \$6.00/yd. Other trim can be selected from Embellishments and the trim is invoiced on a per yard basis.



## Lining

- Available on Flat Roman shades, Panel Track, Panel Drape, Angle Top, Arch Top and Arch shades. Lining extends into the arch or angle.
- Shade and self-valance are lined with high quality polyester/cotton lining. Valance lining can be ordered on unlined shade.
- [See page 53 for color availability](#)
- Lining width is 108". For lined shades greater than 108", can be railroaded to a maximum length of 108".
- Can be combined with edge banding option.
- Lining is inset approximately 1/4" to 1/2" from the edge of the woven material on each side. Areas of light visible through ring holes
- For multiple shades on one headrail, add lining surcharge for each shade.
- Shade lining may need to be "dressed", especially when ordering bulky patterns or shades over 50" wide or long. Dressing helps to train the lining to fall into the folds.

# Measuring and Installation Information

## Roman Shade Brackets

- The type of bracket and size of bracket sent with a roman shade order is dependent on the valance or no valance option specified
- Outside Mount shades are shipped with a New York Style bracket.
- CareRING Cordless shades are shipped with L bracket (PT-SV29).
- Spacer blocks are available if more projection is required

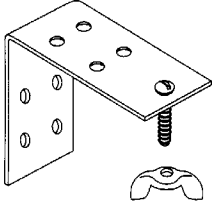

New York Style Bracket  
Outside Bracket  
2" H x 1 7/8" D x 1" W  
RWC-60025

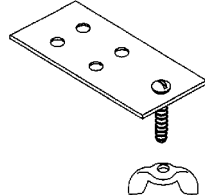

New York Style Bracket  
Ceiling Bracket  
1 3/4" D x 1" W  
RWC-60026

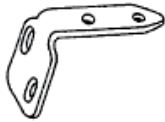

Angle Bracket - 2" Projection  
1 1/2" H x 2 1/8" D x 1" W  
56-2928-08

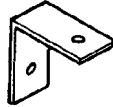

L Bracket - 1" Projection  
1" H x 1" D x 1/2" W  
13-10720

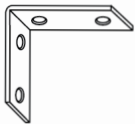

L Bracket - 3" Projection  
3" H x 3" D x 3/4" W  
8-595-0

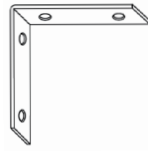

L Bracket - 4" Projection  
4" H x 4" D x 3/4" W  
8-596-0

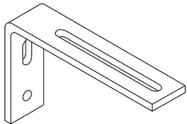

L Bracket for Panel Track  
Inside and Outside Mount  
2" H x 3 1/8" D x 3/4" W  
PT-SV30



Swivel Bracket (Key) for Panel Track  
Inside Mount  
1/4" H x 2" D x 2" W  
TP135-205

Installation Bracket for Panel Drape  
Inside Clip 1 3/8" x 5/8"  
Adjustable Outside Bracket  
1 1/2" H, 2 7/8" to 4 1/4" D  
WB-53202-XX, 25 white or 65 brown

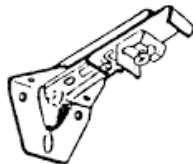

Button Catch for Arch  
Receiver - Item # B0-07000-034  
Catch - Item #702664

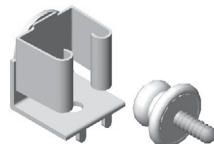

## Light Gap Stop

- Blocks light gap for shades inside mounted in rectangular openings.
- Comes with self adhesive tape attached for installation.
- Projection is 1 5/8".
- Ordered by lineal foot.
- Made of PVC and available in 5 colors: Black, Bronze, Grey, Vanilla and White

## Hold Down Brackets (Roman Shades)

- An oval wooden rod is inserted into hem pocket at bottom of shade and a hole is drilled for hold down bracket attachment.
- Hold down brackets are not available with banding option.
- Hold downs must be specified at the time of the order and cannot be retrofitted in the field.
- Important: The hold down option will affect the thickness of the bottom hem.

Hold Down Bracket  
Item # WWC-900205

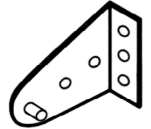

## Cord Tension Lock

- Standard on all Manh Truc Roman Shades with Clutch system.
- Must be secured to the wall to provide the necessary tension for the shade to operate.
- Available in white, vanilla, black, brown, clear, or gray. Will coordinate with the fabric color.



## P Clip Safety Tensioner

- An option in place of a cord tension lock. The clear P-Clip has a torsion spring that will open the tensioner and prevents the chain from sliding through it. The tensioner will then render the shade partially inoperable if it is loose from the wall.

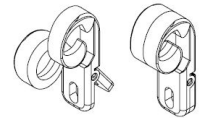

## TLC Roman Shade Child Safe Cord Sleeve

- Child safety design standard on all Manh Truc Roman Shades.
- TLC child safe cord sleeve completely encloses the rear traveling lift cords inside a protective sleeve, anchored every seven inches along back of shade. Confines the cord and eliminates the possibility of cord loops.
- Available in natural, camel, bronze, and gray.
- Lafayette's TLC cord sleeve has been tested by a Consumer Products Safety Commission (CPSC) approved independent laboratory and passed the provisions cited in the American National Standards Institute (ANSI/WCMA A100.1-2010).

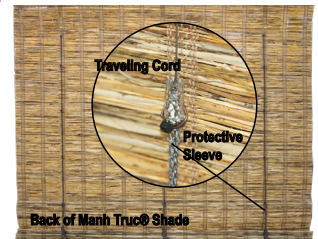

## Advisories

- Each Manh Truc Woven Shade is unique and constructed from all natural materials such as bamboo, wood, reeds and grasses. Slight cracks, wood imperfections and variations in color are inherent to natural products. Color variations may continue to change, lighten or mellow over time making each shade as distinctive as it is beautiful.
- Woven materials within a shade can have a slight bow or camber so that the horizontal lines or bottom hems might not be visually straight, even on shades of the same height. In addition, fold alignment can vary slightly from shade to shade.
- Because of the weight of the materials, shades tend to stretch slightly over time and may touch the sill on an inside installation.
- Most natural patterns do not provide privacy, especially at night. For complete privacy consider using the lining option or a liner shade.
- The natural grass or reed material may have a "grassy" or paint scent, especially after being enclosed during shipping.

# Measuring and Installation Information

## Best Practices for Measuring

- Always use a steel tape or a metal ruler for measuring.
- Always measure every window even though they look the same.
- Check for obstructions that could affect operation of the shade.
- For Inside Mount (jamb to jamb in a window or door, wall to wall in a room), give exact inside to inside width measurements, and top to bottom length measurements of the area to be covered.
- Measure the width in at least three places and specify the narrowest width.
- Measure the length in at least three places and specify the shortest length.
- Take two diagonal measurements. If there is a greater than 3/8" difference in diagonal measurements, outside mount is strongly recommended to avoid irregular light gaps.
- For Outside Mount, measure the exact width and height of the area to be covered.
- For Cloth Measure measurement, the area to cover is given. The overall finished shade width will increase when ordering by the Cloth Measure

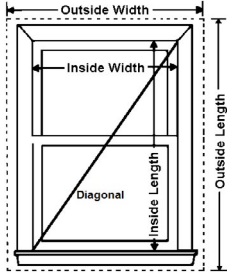

## Roman Shade Measuring

- All shade pricing is based on the width and the height.
- Roman shade orders are accepted for either inside or outside dimensions.
- Shade width measurements should be taken to the nearest 1/16".
- It is critical that the shade brackets are mounted level so that the shade is level when installed.
- Check the projection of the style of roman shades ordered to determine minimum recess.
- For an Inside Mount, we STRONGLY recommend the Traditional style that has the cord and cord lock in front of the material for easy access.
- For Length, measure the full length of the window opening from the top frame to the lower sill (or bottom coverage point) to determine your window length.

## Panel Drape Measuring

- Inside Measurement - For Panel Drape to be installed inside an area (jamb to jamb in a window or door, wall to wall in a room), give exact inside width measurements, and top to bottom length measurements of the area to be covered. DO NOT MAKE ANY ALLOWANCES. The factory will make all deductions so that the track will fit properly into the opening. The Panel Drape will clear the sill or floor approx. 3/8". Designate your measurements INSIDE MOUNT. Warning: For inside mount, the depth required for installation will vary based upon the stiffness of the material selected.
- Outside Measurement - Measure the exact width and height of the area to be covered. No allowances will be made by the factory for length. When measuring from the ceiling to the floor, a deduction of 1/2" is recommended, but you must make this deduction. Designate your measurements OUTSIDE MOUNT. When measuring to cover a window, we recommend the Panel Drape overlap the window by 3" to 6" on each side for privacy and light control. Warning: When installing a Panel Drape above the window frame, the track should be installed at least 2" above the frame or molding to allow the foot of the installation bracket to be properly mounted.

## Panel Track Measuring

- All shade pricing is based on the width and the height.
- Panel Track orders are accepted for either inside or outside dimensions.
- There WILL BE a 1/2" LIGHT GAP on the left and right sides. Consider drapery panels on each side of the opening to conceal the light gap with the inside mount installation.
- Shade width measurements should be taken to the nearest 1/16".
- It is critical that the shade brackets be mounted so that the shade is level when installed.
- For an Inside Mount, For Panel Track to be installed inside an area (jamb to jamb in a window or door, wall to wall in a room), give exact inside width measurements, and top to bottom length measurements of the area to be covered.
- For an Outside Mount, measure the exact width and height of the area to be covered.
- For an Outside Mount, when measuring to cover a window, we recommend the Panel Track overlap the window by 3" to 6" on each side for privacy and light control.
- For Length, measure the full length of the window opening from the top frame to the bottom coverage point) to determine your window length. When installing a Panel Track above the window frame, the track should be installed at least 2" above the frame or molding to allow the foot of the installation bracket to be properly mounted.
- When measuring from the ceiling to the floor, a deduction of 1/2" to 3/4" is recommended, but you must make this deduction.

## Palladian Window Shelf

- Double beaded hardwood shelf designed to mount horizontally in arched or angled openings to serve as divider and mounting surface for any window fashions product
- Allows area above shelf to be covered differently or uncovered
- Finishes available from Woodland Harvest or Heartland Woods
- Palladian shelf has a 1/32" per foot tolerance for warpage
- Inside Mount Applications only

## Size Standards

- Height: 1 1/2"
- Depth: 4" (Can be cut down to 2" minimum upon request)
- Maximum Length: 8'

## Ordering Notes

- Must be installed below the radius of window as routed ends are square
- Specify exact width from jamb to jamb. A 1/16" deduction will be taken by Lafayette
- Ordered separate from Manh Truc shade (Priced by lineal foot - round up from exact width to next highest lineal foot)
- Exclusions: Outside mount applications

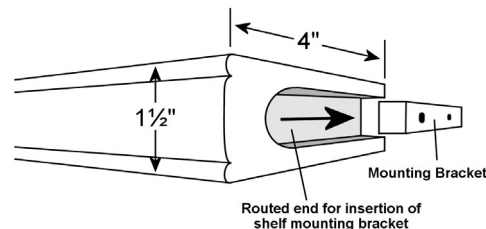

## Flame Retardant (FR) Coating or Antimicrobial

- A flame retardant or antimicrobial coating is available for Genesis fabrics without these inherent properties. The shade is fabricated then sent to an external facility for the flame coating or antimicrobial process. Allow four to six weeks extra delivery time for this service. Standard shipping is included. Call for quote on flame retardant or antimicrobial coating.

For more Measuring and Installation info, visit the [Lafayette Dealer Center](#) website.

# Manh Truc Color Line

Manh Truc Custom Woven Collection Color Line					
Pattern Name	Color Name	Color #	Pattern Name	Color Name	Color #
Akela	Sunset	796	Lani	Natural	540
Akela	White	885	Lani	Rice	690
Akela	Dawn	260	Lea	Desert	270
Akela	Malt	460	Lea	Dawn	260
Akela	Fog	348	Lea	Cashmere	257
Akela	Beach Blush	206	Malana	Pewter	083
Akela	Seaglass	728	Malana	Coconut	014
Akela	Smoke	802	Mayli	Twilight	852
Aris	Ginger	361	Mayli	Fog	348
Bacopa	Camel	139	Mayli	Vapor	888
Batang	White	885	Meeka	Luxe Lace	572
Bayani	Shell	760	Meeka	Cork	102
Beijing	Desert	270	Meeka	Driftwood	291
Beijing	Dusk	298	Meeka	Coral Reef	228
Caracas	Teak	758	Miya	Toffee	841
Caracas	Ginger	361	Miya	Azure	058
Chakra	Smoke	802	Miya	Cornsilk	231
Chakra	White	885	Miya	Moonlight	552
Chakra	Desert	270	Naoki	Marine	033
Chakra	Malt	460	Naoki	White	885
Chakra	Pecan	615	Naoki	Malt	460
Chinda	White	885	Naoki	Whitewash	862
Chinda	Camel	139	Naoki	Dove	143
Chinda	Taupe	840	Naoki	Nutmeg	543
Dieu	White	885	Nara	Tuxedo	250
Dieu	Oatmeal	556	Nara	Sterling	821
Georgie	Sand	041	Okalani	Coral Reef	228
Hanoi	Camel	139	Okalani	Tiger	847
Jambu	Whitewash	862	Okalani	Fog	348
Jambu	White Sands	886	Okalani	Tortoise	118
Jambu	Rye	716	Okalani	Pumice	607
Jambu	Smoke	802	Sapporo	Malt	460
Jambu	Adobe	005	Sapporo	White	885
Jilin	Natural	540	Sasarido	Ebony	318
Kaila	Greige	827	Sibu	Natural	540
Kaila	Sand Dunes	042	Srilanka	Mink	216
Kaliko	Smoke	802	Ulani	Walnut	891
Karina	Pewter	083	Waja	Malt	460
Karina	Silver Moon	783	Waja	Ebony	318
Karina	Driftwood	291	Zaru	Horizon	984
Karina	Stardust	109	Zaru	Sugar	797
Kato	Mink	216	Zaru	Fog	348
Keani	Snow	805	Zuki	Natural	540
Kwan	Warm White	883	Zuki	Rice	690
Lani	Fog	348	Zuki	Fog	348
Lani	Smoke	802	Zuki	Ebony	318

Manh Truc Linings			
Light Filtering		Opaque	
Snowflake	168	Snow	805
Silver	780	Cream	235
Midnight	505	Birch	411
Gold Dust	368	Buff	130
Iceberg	421	Slate	800
Coffee Bean	926	Ebony	318

Manh Truc Banding			
Fabric Banding		Twill Banding	
Aloe	011	Basil	021
Bone	120	Black	995
Cocoa	208	Claret	875
Coin	203	Cocoa	290
Granite	375	Khaki	559
Ivory	420	Loden	597
Linen	455	Natural	175
Spruce	822	Nutmeg	270
Teal	845	Sand	566
Truffle	857	Smoke	802
Tuxedo	854	Spa	806
Winter	898	Taupe	166
		White	010





Midwest  
Designer  
Supply

**1-888-523-2611**

**Midwest Designer Supply, Inc.  
N30W22377 Green Road Ste C  
Waukesha, WI 53186  
(262) 523-2600  
Fax (262) 524-1007  
[www.midwestdesignersupply.com](http://www.midwestdesignersupply.com)**

***MDS - your one source for window fashions.***